

# CISNE

Kugelführung



1 CISNE-17

■ CISNE-17 Kurz

Kugelauszug Schraubmontage oder Schnellmontage ARPON.

Schubkastenlänge	Artikelnummer	Schubkastenschiene			Korpusschiene			Auszugsverlust			Bohrung			Abstand
		RC	RF	PS	A1	A2	A3	B	A1	A2	A3	B		
152 a 210	776.134.752	134	151	59	96	-	-	103						
220 a 260	776.159.753	159	183	59	64	-	64	128						
270 a 310	776.183.752	183	183	59	64	-	64	152						
315 a 355	776.215.753	215	215	77	64	32	64	184					50	
370 a 410	776.243.753	243	247	77	64	64	64	212						
420 a 460	776.277.751	277	279	95	64	96	64	246						
470 a 510	776.311.756	311	311	113	64	128	64	280						
520 a 560	776.335.755	335	343	113	64	160	64	304						

Jede Artikelnummer besteht aus einem Satz Führungen.

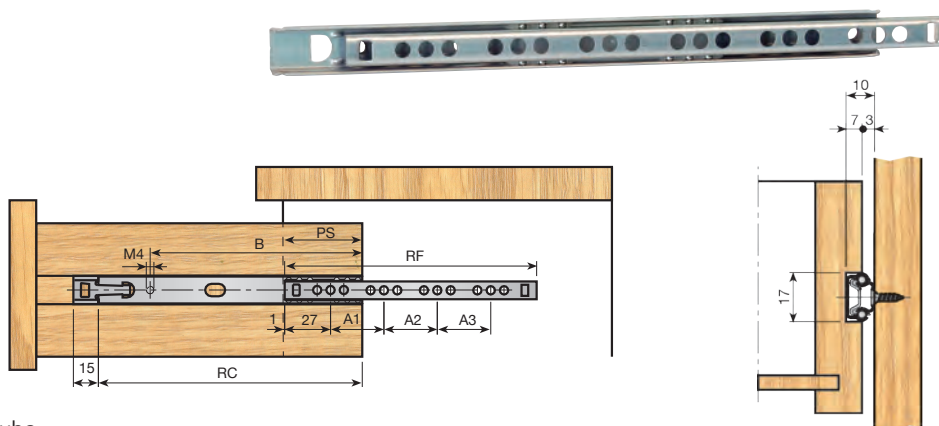

Befestigungsschraube.

M4 x 7	730.507.035	1.000	
M4 x 8	730.508.030	oder	
M4 x 10	730.510.034	5.000	

ARPON-17 Schnellmontage-System.

Edelstahl	732.517.100	500 oder 2.000	
-----------	-------------	----------------	--

Schnellmontage-System ARPÓN

Präzisionskugelführung für Schubkästen mit Nut. Leichter Lauf und hohe Seitenstabilität. Beidseitig einsetzbar.



**2 CISNE-27**

**CISNE-27-0: Teilauszug**

Kugelauszug Schraubmontage oder Schnellmontage **ARPON**.

Schubkastenlänge	Artikelnummer	Schubkastenschiene Korpuschiene Auszugsverlust			Bohrung Abstand		
		RC	RF	PS	A	B	
300	781.030.751	196	214	71	32	165	25
350	781.035.754	221	214	71	32	190	
400	781.040.750	246	246	71	64	215	
450	781.045.753	277	278	83	96	246	
500	781.050.756	302	310	83	128	271	
550	781.055.752	327	342	83	160	296	

Jede Artikelnummer besteht aus einem Satz Führungen.

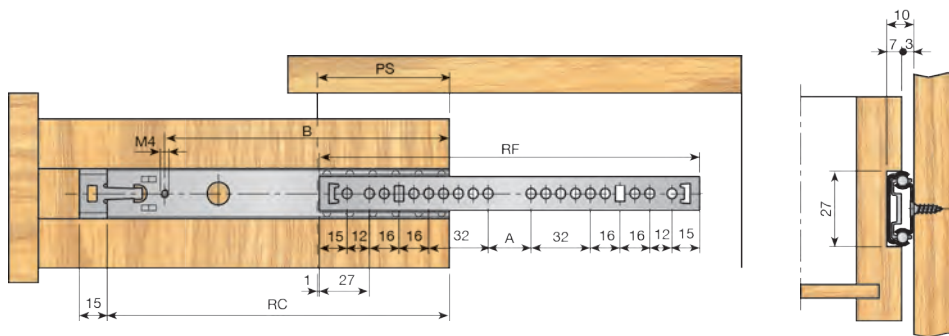

Befestigungsschraube.

		
M4 x 7	730.507.035	1.000
M4 x 8	730.508.030	oder
M4 x 10	730.510.034	5.000



ARPON-27 Schnellmontage-System.

		
Edelstahl	732.527.106	500 oder 2.000



**Schnellmontage-System ARPÓN**

Präzisionskugelführung für Schubkästen mit Nut. Leichter Lauf und hohe Seitenstabilität. Beidseitig einsetzbar.



■ CISNE-27-0: *Vollauszug*

Kugelauszug Schraubmontage oder Schnellmontage **ARPON**.

Schubkastenlänge	Artikelnummer	Schubkastenschiene		Bohrung		Abstand		
		RC	RF	A	B			
300	781.230.752	196	214	32	165			
350	781.235.755	221	214	32	190			
400	781.240.751	246	246	64	215			15
450	781.245.754	277	278	96	246			
500	781.250.750	302	310	128	271			
550	781.255.753	327	310	160	296			

Jede Artikelnummer besteht aus einem Satz Führungen.

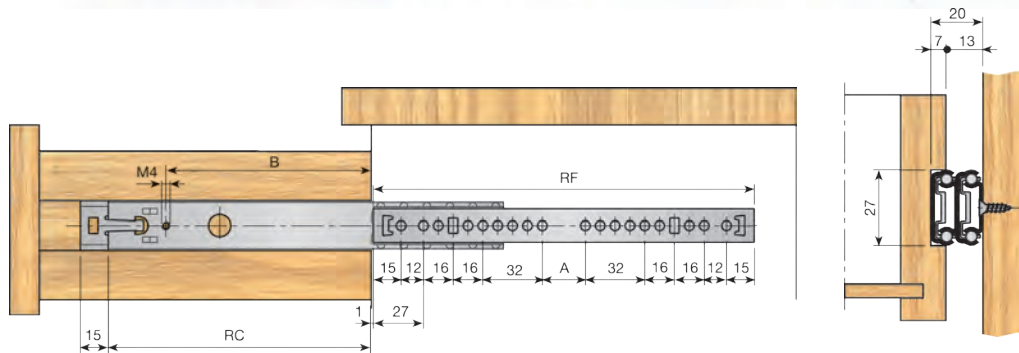
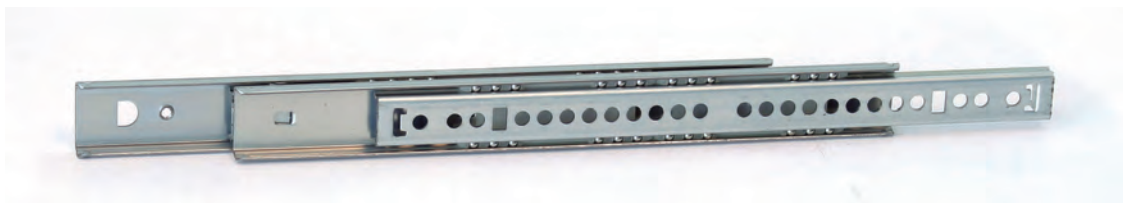

Befestigungsschraube.

M4 x 7	730.507.035	1.000	
M4 x 8	730.508.030	oder	
M4 x 10	730.510.034	5.000	



**ARPON-27 Schnellmontage-System.**

Edelstahl	732.527.106	500 oder 2.000	
-----------	-------------	----------------	---



*Schnellmontage-System ARPÓN*

Präzisionskugelführung für Schubkästen mit Nut. Leichter Lauf und hohe Seitenstabilität. Beidseitig einsetzbar.



■ CISNE-27-1

Bodenmontage.

Schubkastenlänge	Artikelnummer	Schubkastenschiene			Auszugsverlust	Bohrung		Abstand	
		RC	RF	PS		A	B		
300	781.130.755	236	214	71	32	202	50		
350	781.135.751	261	214	71	32	227			
400	781.140.754	286	246	71	64	252			
450	781.145.750	317	278	83	96	283			
500	781.150.753	342	310	83	128	308			
550	781.155.756	367	342	83	160	333			

Jede Artikelnummer besteht aus einem Satz Führungen.

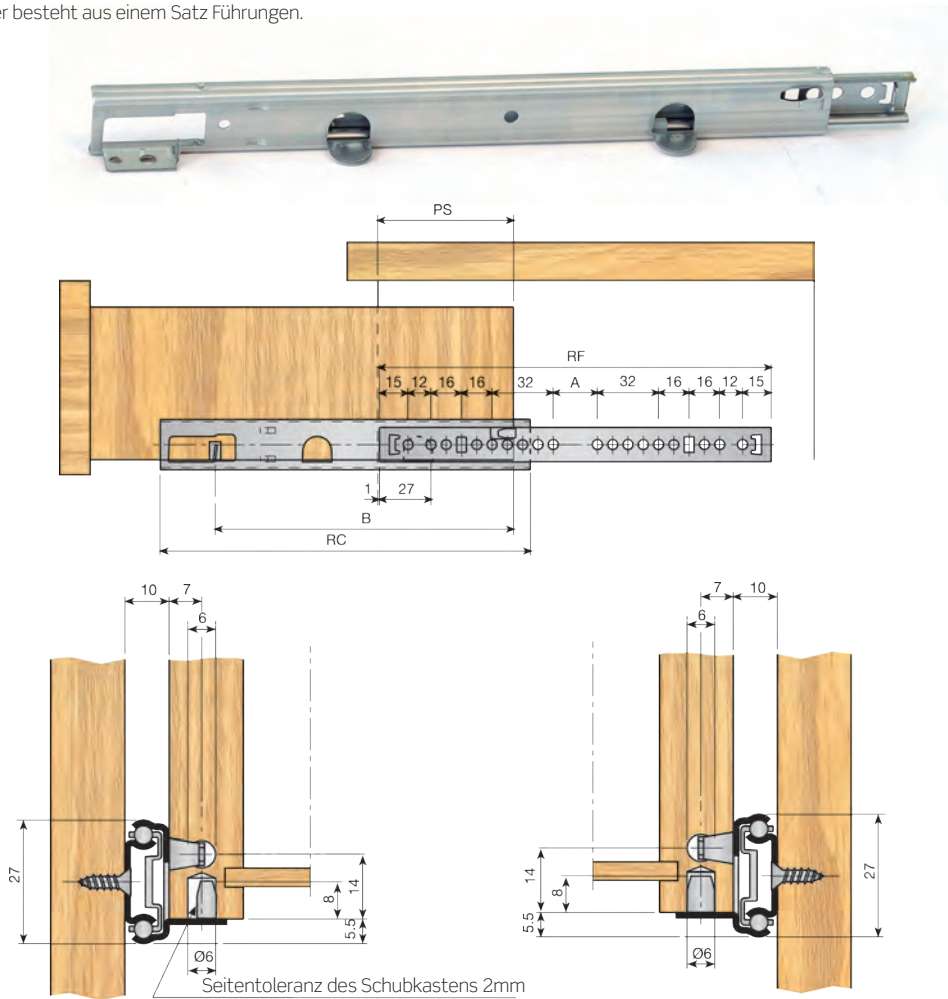

Montage

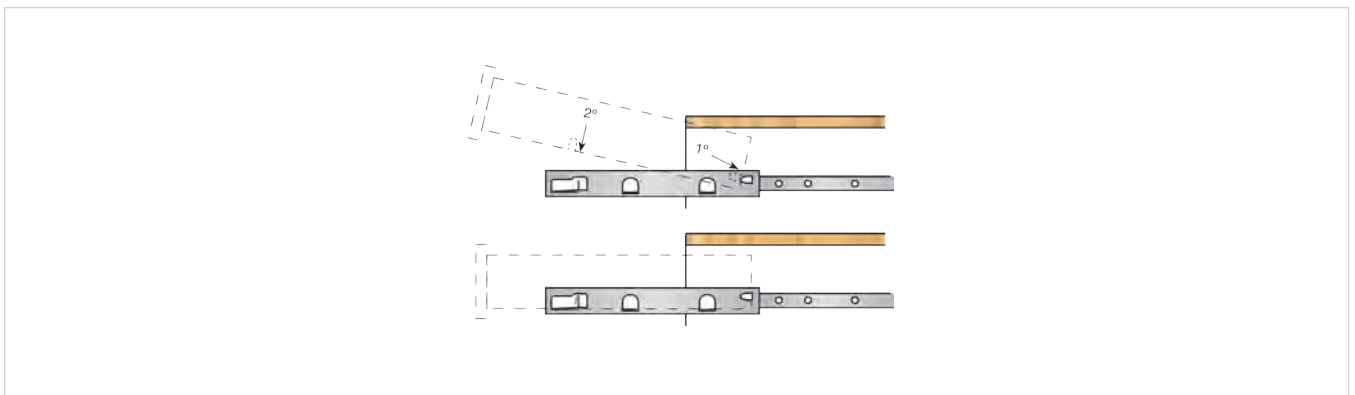

3 CISNE 17/27 MIT INDAmatic

INDAmatic Satz für CISNE ohne Bremse.

Gedämpften Satz + Befestigungsbeschlag.

Grau CDP	197.900.102	50
----------	-------------	----

Jede Artikelnummer besteht aus einem Dämpfungssystem und einem Befestigungsbeschlag.

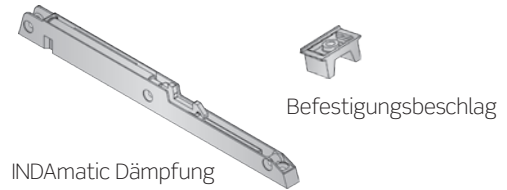

Montage und Einstellung

Befestigung seitlich

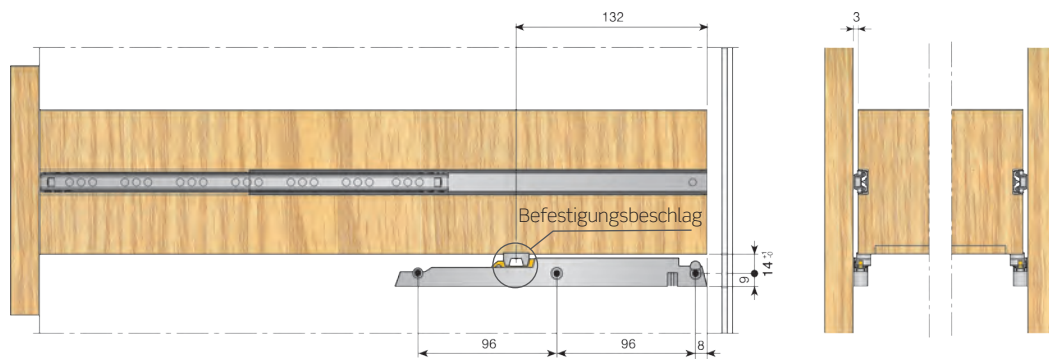

Die Befestigungsbeschläge werden an dem Schubkasten befestigt.

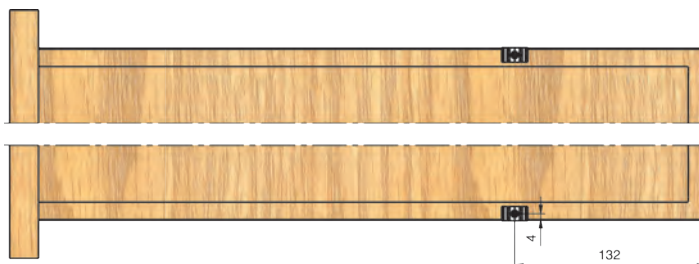

■ CISNE-17



Kugelauszug kurz CISNE-17 ohne Bremse.

Schubkastenlänge	Artikelnummer	Schubkastenschiene			Auszugsverlust	Bohrung			Abstand	
		RC	RF	PS		A1	A2	A3		
152 a 210	776.513.754	134	151	59	96	-	-	103	50	
220 a 260	776.515.751	159	183	59	64	-	64	128		
270 a 310	776.518.750	183	183	59	64	-	64	152		
315 a 355	776.521.756	215	215	77	64	32	64	184		
370 a 410	776.524.755	243	247	77	64	64	64	212		
420 a 460	776.527.754	277	279	95	64	96	64	246		
470 a 510	776.531.755	311	311	113	64	128	64	280		
520 a 560	776.533.752	335	343	113	64	160	64	304		

Jede Artikelnummer besteht aus einem Satz Führungen.

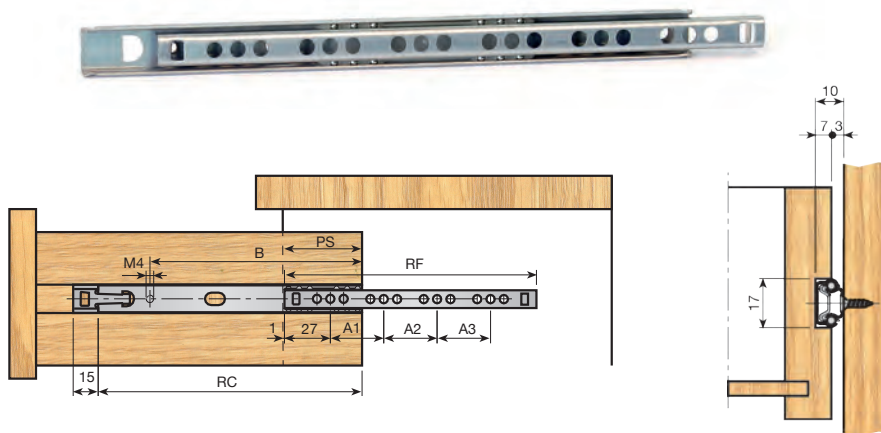

Montage und Einstellung

Befestigung seitlich

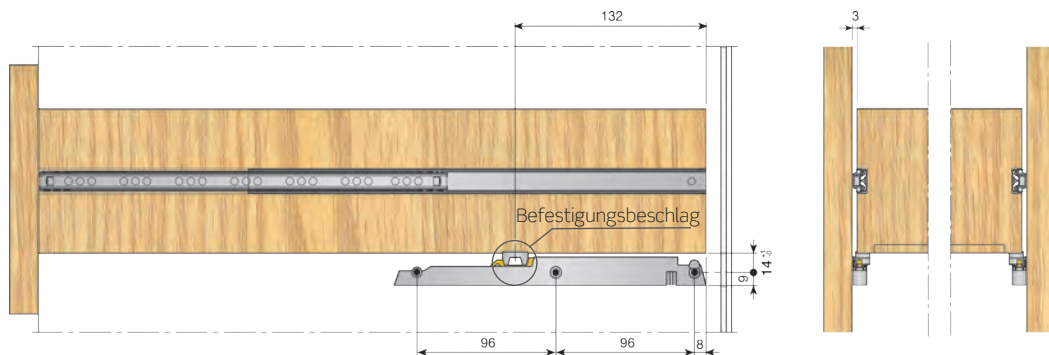

Die Befestigungsbeschläge werden an dem Schubkasten befestigt.

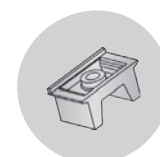
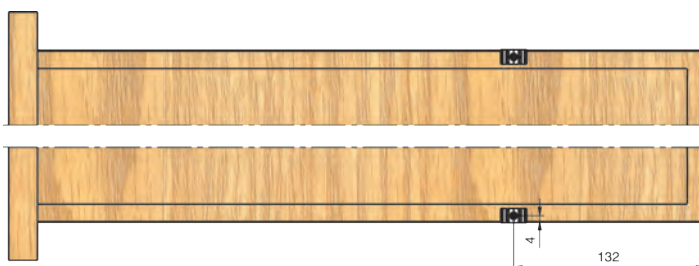

■ CISNE-27-0: Teilauszug

Kugelauszug CISNE 27-0 ohne Bremse.

Schubkastenlänge	Schubkastenschiene			Auszugsverlust	Bohrung	Abstand		
	Artikelnummer	RC	RF			PS	A	
300	776.619.756	196	214	71	32	165	25	
350	776.622.755	221	214	71	32	190		
400	776.624.752	246	246	71	64	215		
450	776.627.751	277	278	83	96	246		
500	776.630.750	302	310	83	128	271		
550	776.632.754	327	342	83	160	296		

Jede Artikelnummer besteht aus einem Satz Führungen.

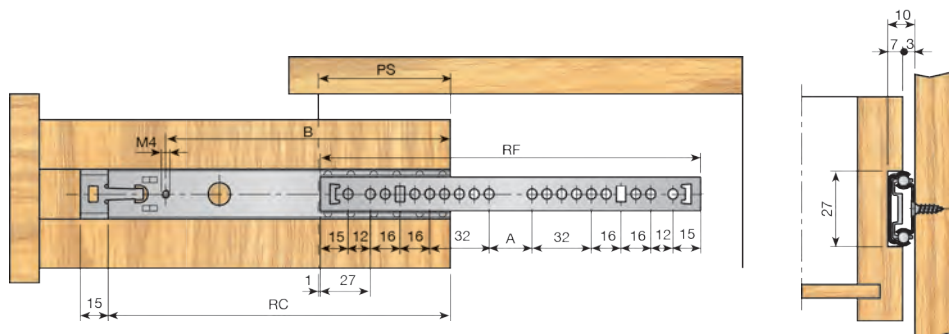

Montage und Einstellung

Befestigung seitlich

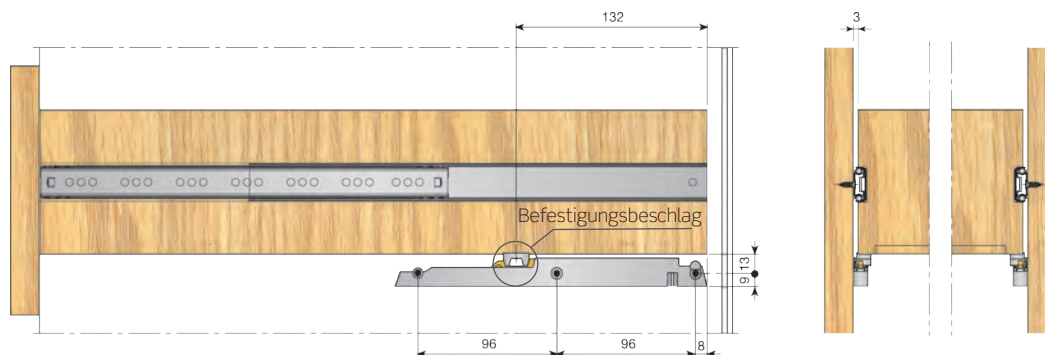

Die Befestigungsbeschläge werden an dem Schubkasten befestigt.

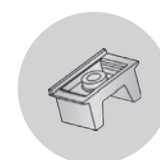
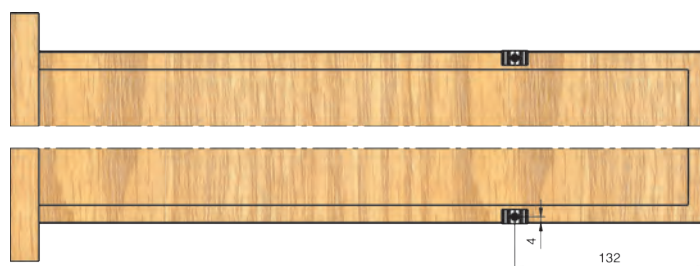



4 CISNE-35

Führung C35 x 9.7mm, für Holzschubkasten.

Schubkastenlänge	Auszugsverlust	Artikelnummer	
250	65	778.825.751	20
300	85	778.830.754	
350	105	778.835.750	
400	100	778.840.753	
450	112	778.845.756	15
500	125	778.850.752	
600	150	778.860.751	10
700	175	778.870.750	

Jede Artikelnummer besteht aus einem Satz Führungen.

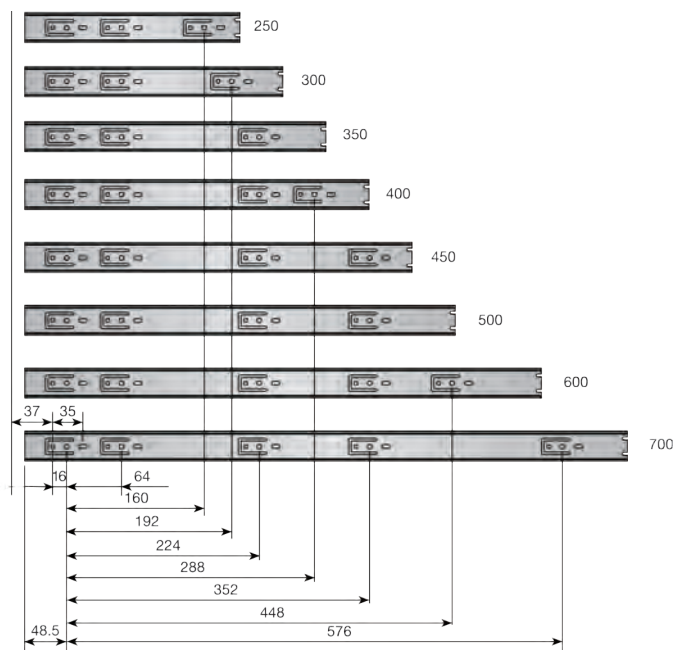
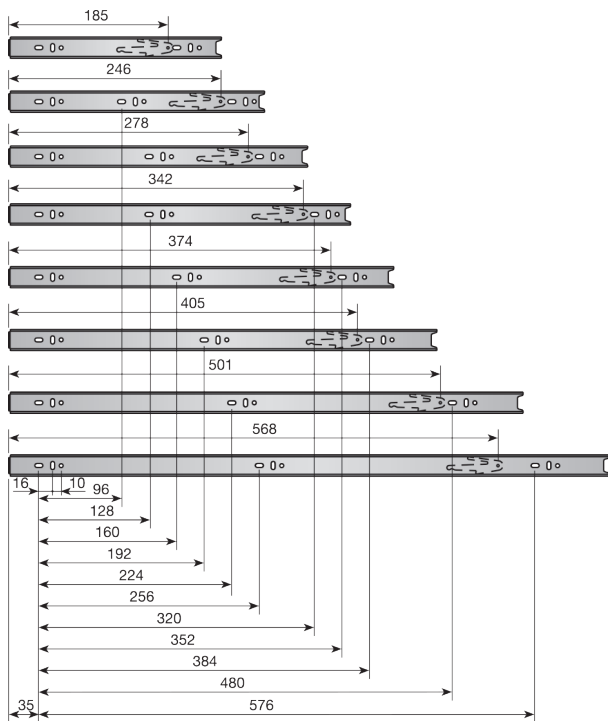

Montage

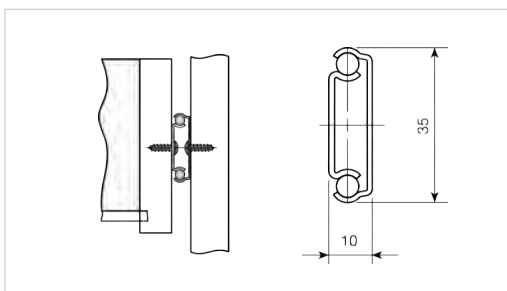

A	250	300	350	400	450	500	600	700
B	140	202	234	298	330	361	457	520

5 CISNE-45

■ CISNE-45-X2

Vollauszug C45-X2, für Holzschubkasten.

Schubkastenlänge	Artikelnummer	
250	785.025.754	10
300	785.030.750	
350	785.035.753	
400	785.040.753	
450	785.045.752	
500	785.050.755	5
550	785.055.751	
600	785.060.754	
650	785.065.750	
700	785.070.753	

Jede Artikelnummer besteht aus einem Satz Führungen.

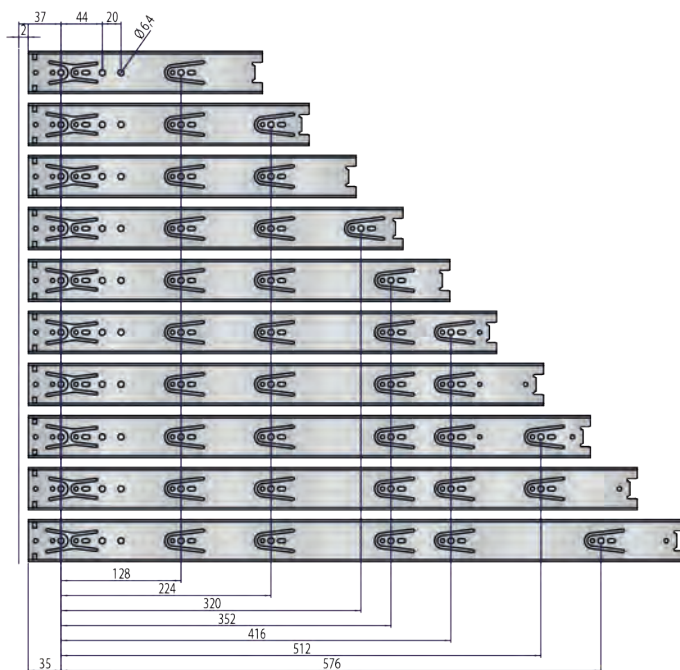
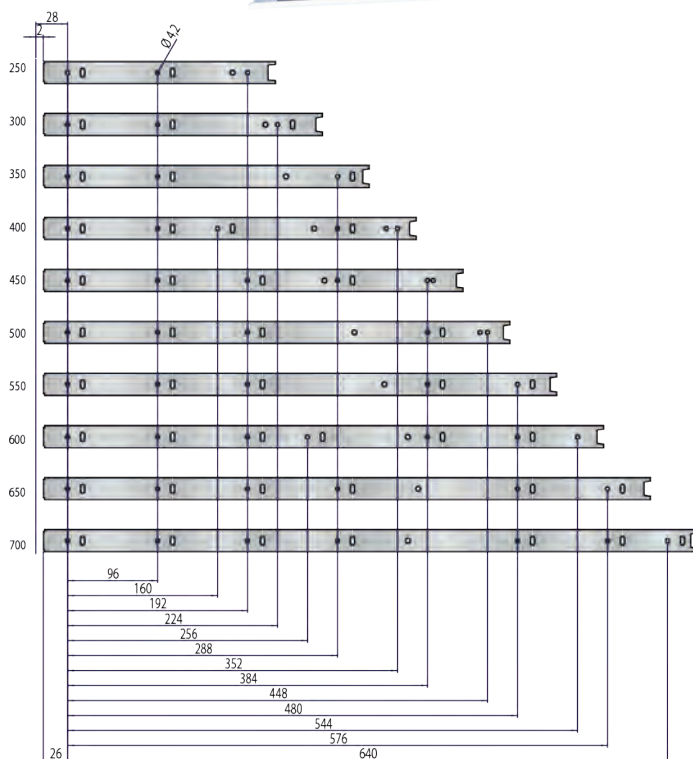

Montage

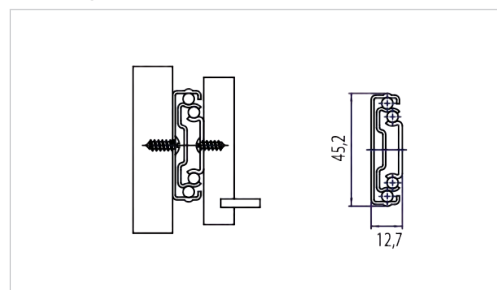

A	250	300	350	400	450	500	550	600	650	700
B	242	304	357	407	457	507	555	604	657	707

■ CISNE-45-X2 PUSH

Vollauszug C45-X2 PUSH, für Holzschubkasten.

Schubkastenlänge	Artikelnummer	
300	785.230.751	10
350	785.235.754	
400	785.240.750	
450	785.245.753	
500	785.250.756	
550	785.255.752	5
600	785.260.755	

Jede Artikelnummer besteht aus einem Satz Führungen.

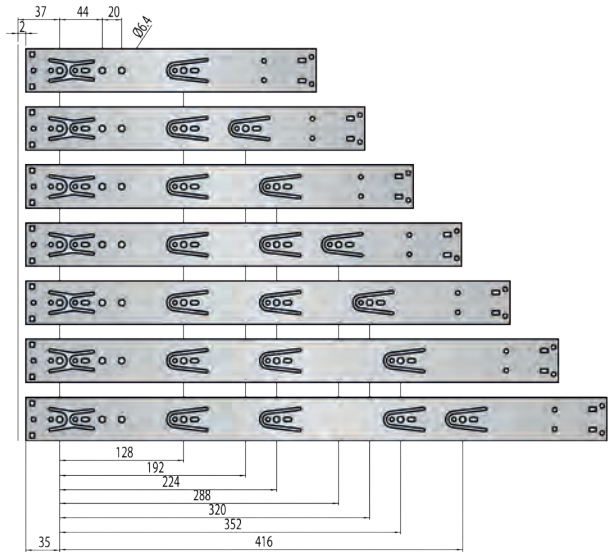
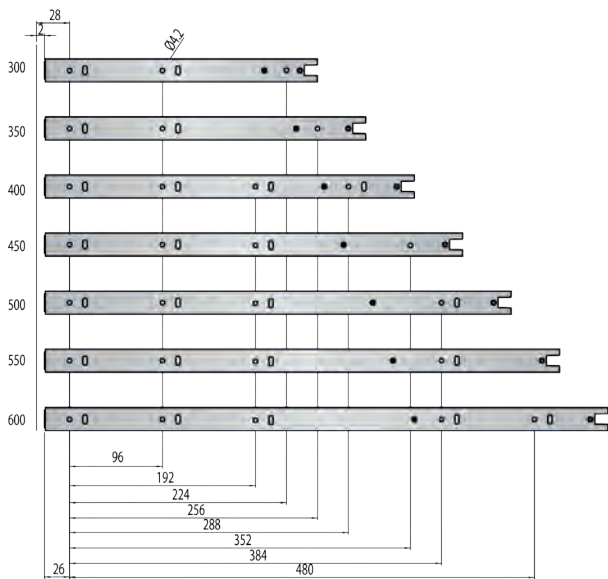

Montage

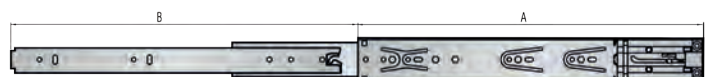
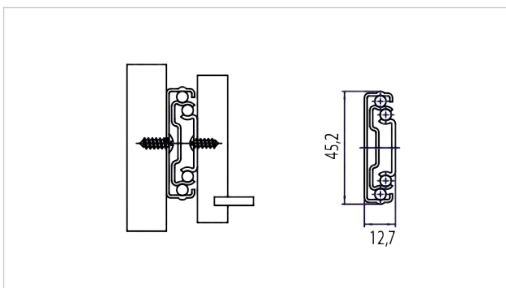

A	300	350	400	450	500	550	600
B	300	350	400	450	500	550	600

6 CISNE-45

■ CISNE-45-X2 INDAMATIC

Vollauszug C45-X2 INDAMATIC, für Holzschubkasten.

Schubkastenlänge	Artikelnummer	
300	785.130.754	10
350	785.135.750	
400	785.140.753	
450	785.145.756	
500	785.150.752	5
550	785.155.755	
600	785.160.751	

Jede Artikelnummer besteht aus einem Satz Führungen.

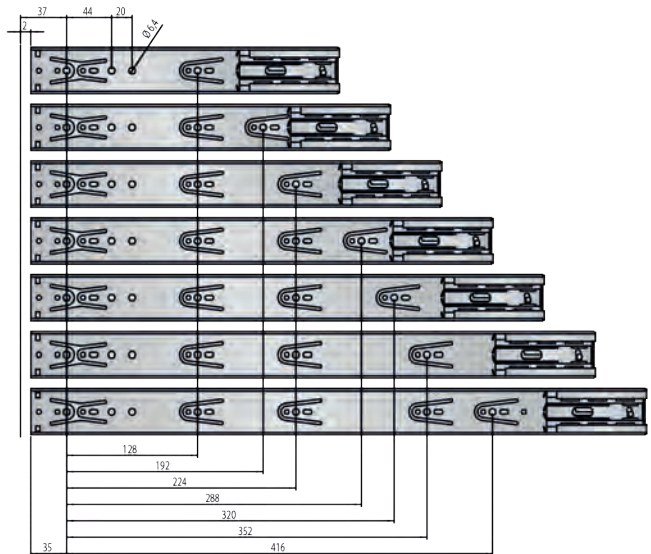
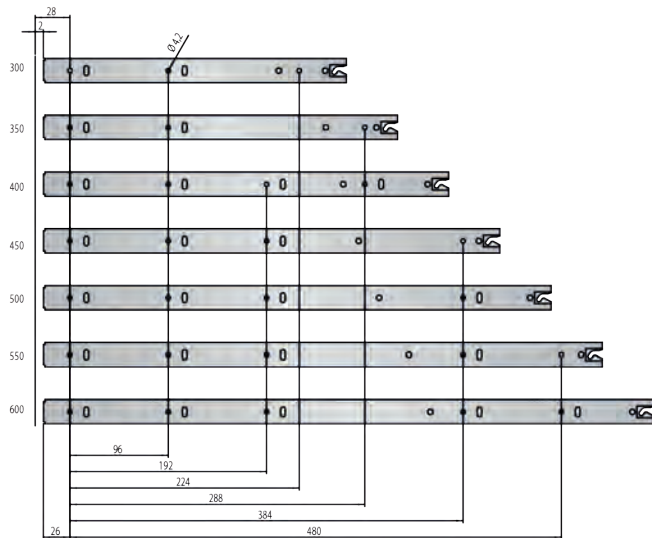

Montage

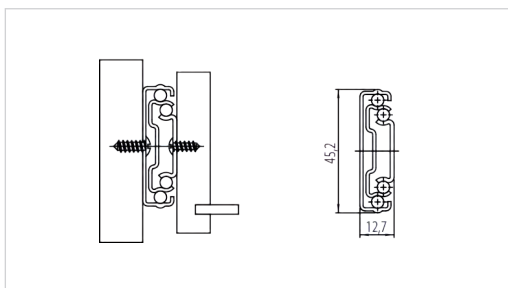

A	300	350	400	450	500	550	600
B	288	350	404	454	504	554	604