

EXZENTERVERBINDER Ø25

1	EXZENTER UND ABDECKKAPPEN		200
<hr/>			
2	VERBINDUNGSBOLZEN		201
<hr/>			
3	MUFFEN		202

EXZENTERSCHNECKE Ø25

1	EXZENTER UND ABDECKKAPPEN		204
<hr/>			
2	VERBINDUNGSBOLZEN		205
<hr/>			
3	MUFFEN		206

1 EXZENTERVERBINDER UND ABDECKKAPPEN

Abdeckkappe Ø25mm.

Farbe			
Weiß	RAL 9003	530.400.006	2.000
Braun	RAL 8016	530.400.010	
Schwarz	RAL 9005	530.400.021	
Grau	RAL 7040	530.400.312	
Vernickelt		530.400.065	

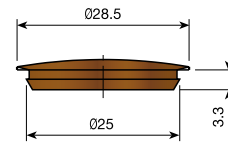

Abdeckkappe mit Anschlagstift Ø25mm.

Farbe			
Weiß	RAL 9003	530.100.001	2.000
Braun	RAL 8016	530.100.012	
Schwarz	RAL 9005	530.100.023	

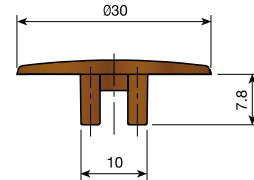

Exzenterverbinder Ø25mm.

Farbe			
Naturbelassen		510.011.106	2.000

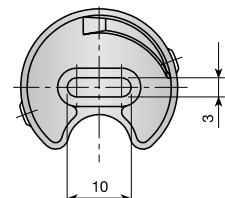
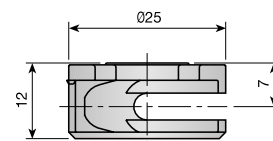

2 VERBINDUNGSBOLZEN

Holzgewindeverbindungsbolzen.

Bohrdistanz 33mm. 
 Verzinkt 520.839.034 2.000

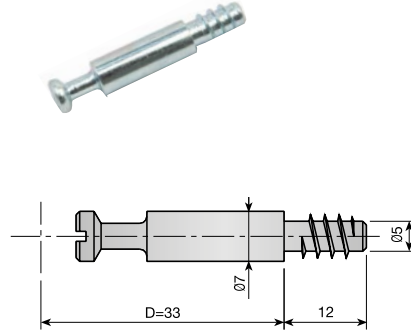
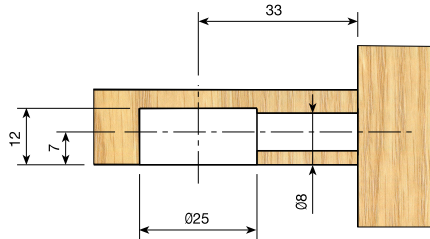

Verbindungsbolzen M6.

Bohrdistanz 33mm. 
 Verzinkt 520.735.036 2.000

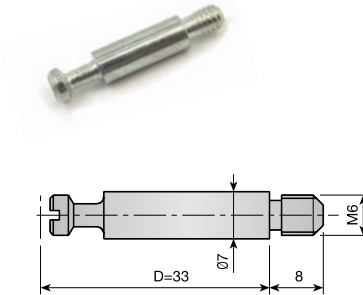
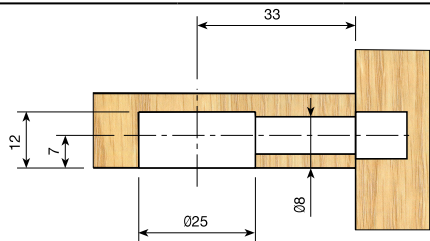

Doppelverbindungsbolzen.

Farbe 
 Verzinkt 522.077.032 1.000

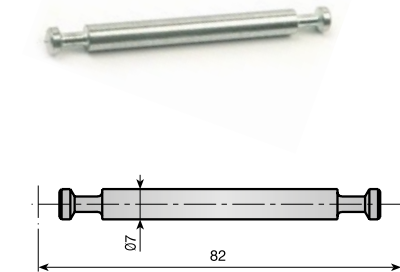
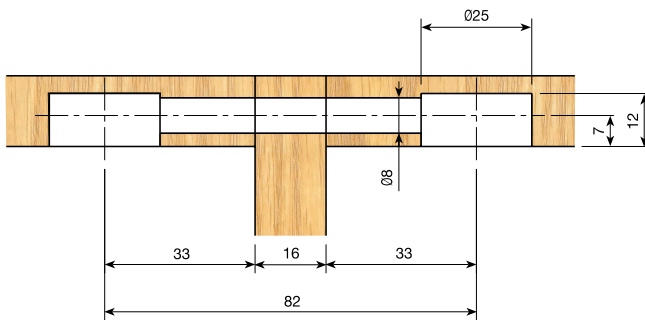

Doppelverbindungsbolzen 90°.

Farbe 
 Verzinkt 522.100.036 1.000

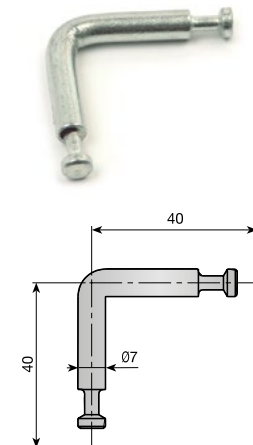
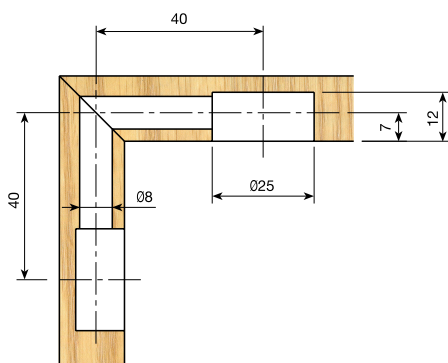

3 MUFFEN

Muffe mit Holzgewinde ohne Kopf.

Verzinkt					
L (mm.)	Ød(mm.)	ØD (mm.)	1/4"	M6	
10	8	10	947.510.034	947.810.032	2.500
12	8	10	947.512.031	947.812.036	2.000
14	8	10	947.514.035	947.814.033	2.000
18	8	10	947.518.036	947.818.034	2.000
22	8	10	947.522.030	947.822.035	2.000
10	9	12	947.610.031	947.910.036	2.000
12	9	12	947.612.035	947.912.033	2.000
14	9	12	947.614.032	947.914.030	2.000
16	9	12	947.616.036	947.916.034	2.000
18	9	12	947.618.033	947.918.031	2.000

L (mm.)	Ød(mm.)	ØD (mm.)	M8	
22	11	14	948.222.030	1.500

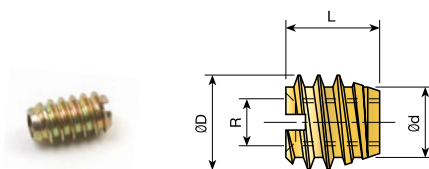

Messingmuffe selbstspreizend.

M4	
944.805.105	2.000 oder 10.000

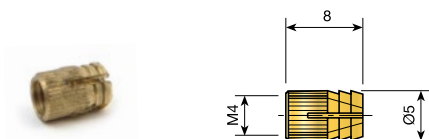

Messingmuffe M6 selbstspreizend.

M6	
Ø8 x 12mm. 944.112.105	5.000

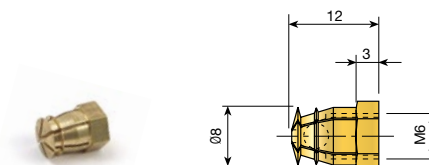

Muffe M6 mit Holzgewinde.

Farbe	1/4"	M6	
Vernickelt	948.813.062		2.000
Verzinkt		948.913.033	

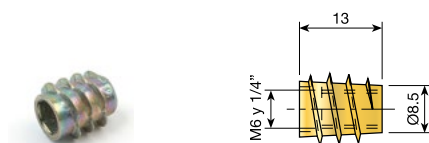

Muffe m6 mit Holzgewinde und Kopf.

Farbe	M4	1/4"	M6	M8	
Vernickelt		948.613.061			2.000
Verzinkt	948.413.034		948.713.032	948.575.036	

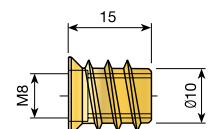
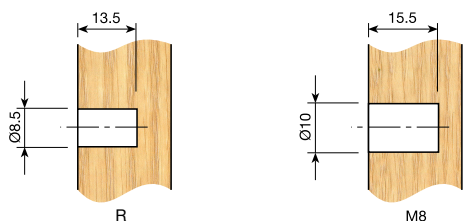
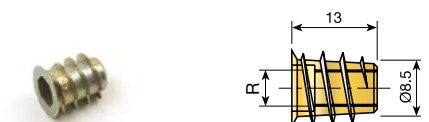

Gewindemuffe M4 Nylon Ø8.

				
Natur		937.004.106		2.000 oder 10.000
Braun	RAL 8016	937.004.014		

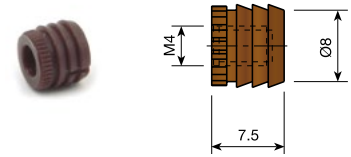

Gewindemuffe Nylon Ø10.

R	M6	1/4"		
Natur	937.006.103	937.014.105		2.000 oder 10.000
Braun	RAL 8016 937.006.011	937.014.013		
Schwarz	RAL 9005 937.006.022	937.014.024		

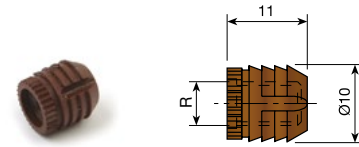

Gewindemuffe Nylon Ø11.

R	M6	1/4"		
Natur	937.106.100	937.114.102		4.000
Braun	RAL 8016 937.106.015	937.114.010		

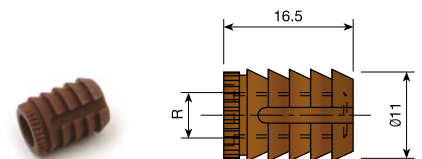

Gewindemuffe M6 Nylon Ø10, Streifen.

				
Natur		937.406.105		4.800
Braun	RAL 8016	937.406.013		
Schwarz	RAL 9005	937.014.024		

Jeder Karton enthält 200 Streifen.
24 Stück pro Streifen; die Anbringung kann manuell oder durch Pistole mit Ladevorrichtung erfolgen.

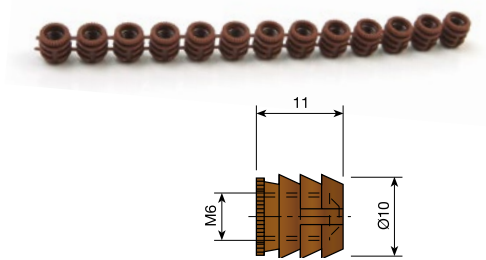

Gewindemuffe M6 Stahl gerändelt

L	16mm.	18mm.		
Verzinkt	938.716.100	938.718.104		1.000 oder 5.000

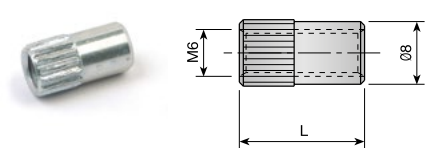

1 EXZENTERVERBINDER UND ABDECKKAPPEN

Abdeckkappe Ø25mm.

Farbe			
Weiß	RAL 9003	530.400.006	
Braun	RAL 8016	530.400.010	2.000
Schwarz	RAL 9005	530.400.021	
Grau	RAL 7040	530.400.312	
Vernickelt		530.400.065	1.000

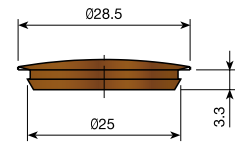

Exzenter-schnecke Ø25mm. Dünn.

Farbe / R			
Vernickelt		510.308.035	2.000

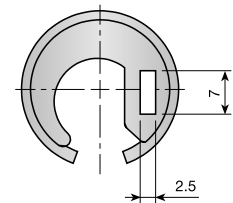
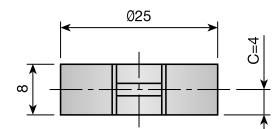

Exzenter-schnecke Ø25mm. Dick.

Farbe / R			
Vernickelt		510.211.030	1.000

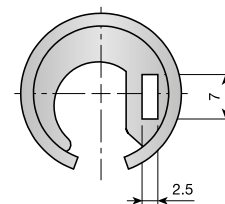
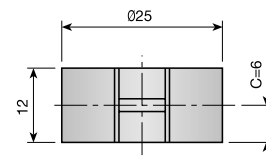

2 VERBINDUNGSBOLZEN

Verbindungsbolzen mit Öse M6.

Bohrdistanz 33mm.

Vernickelt

520.937.034

2.000

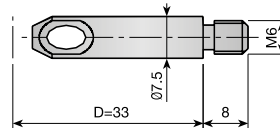
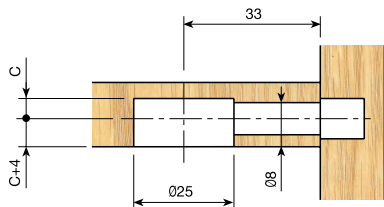

Verbindungsbolzen mit Doppelöse.

Farbe / R

Vernickelt

521.079.031

1.000

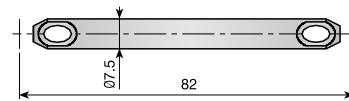
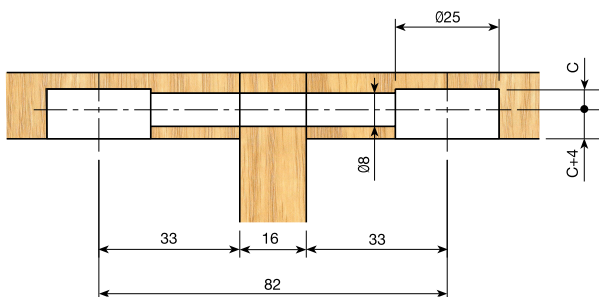

Verbindungsbolzen 90° mit Doppelöse.

Farbe / R

Vernickelt

521.100.031

1.000

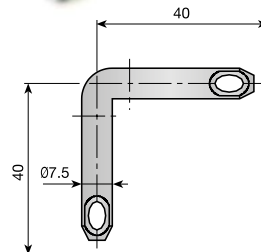
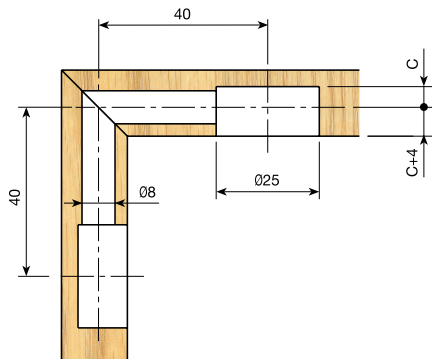

3 MUFFEN

Muffe mit Holzgewinde ohne Kopf.

Verzinkt					
L (mm.)	Ød(mm.)	ØD (mm.)	1/4"	M6	
10	8	10	947.510.034	947.810.032	2.500
12	8	10	947.512.031	947.812.036	2.000
14	8	10	947.514.035	947.814.033	2.000
18	8	10	947.518.036	947.818.034	2.000
22	8	10	947.522.030	947.822.035	2.000
10	9	12	947.610.031	947.910.036	2.000
12	9	12	947.612.035	947.912.033	2.000
14	9	12	947.614.032	947.914.030	2.000
16	9	12	947.616.036	947.916.034	2.000
18	9	12	947.618.033	947.918.031	2.000

L (mm.)	Ød(mm.)	ØD (mm.)	M8	
22	11	14	948.222.030	1.500

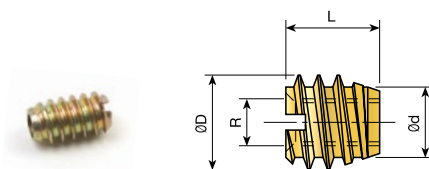

Messingmuffe selbstspreizend.

M4			
944.805.105	2.000 oder 10.000		

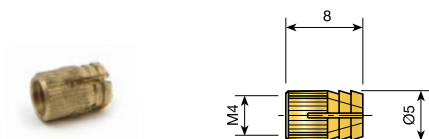

Messingmuffe M6 selbstspreizend.

M6			
Ø8 x 12mm.	944.112.105	5.000	

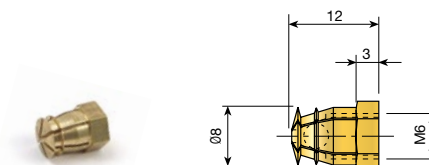

Muffe M6 mit Holzgewinde.

Farbe	1/4"	M6	
Vernickelt	948.813.062		2.000
Verzinkt		948.913.033	

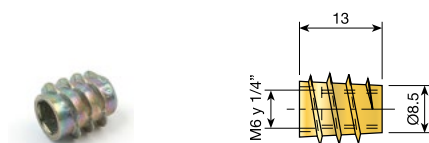

Muffe m6 mit Holzgewinde und Kopf.

Farbe	M4	1/4"	M6	M8	
Vernickelt		948.613.061			2.000
Verzinkt	948.413.034		948.713.032	948.575.036	

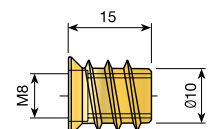
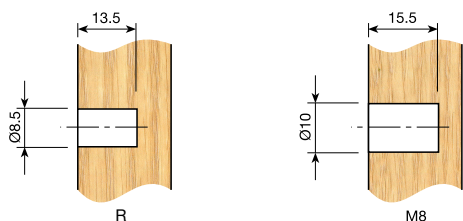
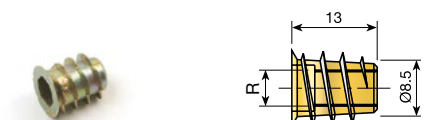

Gewindemuffe M4 Nylon Ø8.

				
Natur		937.004.106		2.000 oder 10.000
Braun	RAL 8016	937.004.014		

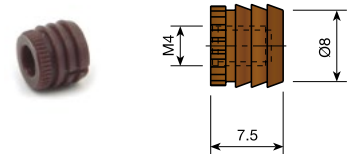

Gewindemuffe Nylon Ø10.

R	M6	1/4"		
Natur	937.006.103	937.014.105		2.000 oder 10.000
Braun	RAL 8016 937.006.011	937.014.013		
Schwarz	RAL 9005 937.006.022	937.014.024		

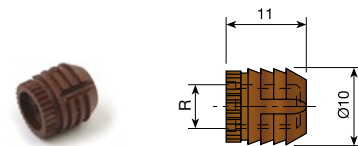

Gewindemuffe Nylon Ø11.

R	M6	1/4"		
Natur	937.106.100	937.114.102		4.000
Braun	RAL 8016 937.106.015	937.114.010		

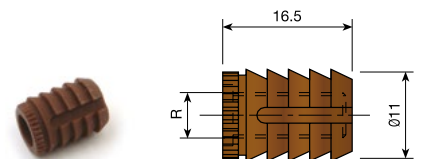

Gewindemuffe M6 Nylon Ø10, Streifen.

				
Natur		937.406.105		4.800
Braun	RAL 8016	937.406.013		
Schwarz	RAL 9005	937.014.024		

Jeder Karton enthält 200 Streifen.
24 Stück pro Streifen; die Anbringung kann manuell oder durch Pistole mit Ladevorrichtung erfolgen.

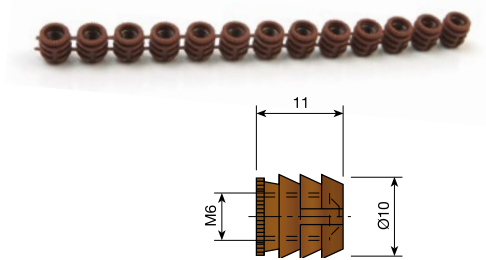

Gewindemuffe M6 Stahl gerändelt

L	16mm.	18mm.		
Verzinkt	938.716.100	938.718.104		1.000 oder 5.000

