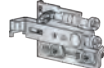
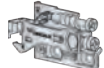

SCARPI-4

Schrankschrankaufhänger

Hochleistungsschrankschrankaufhänger: 45 kg/Stück im Prüfgestell A und 35 kg/Stück im Prüfgestell B nach EN 15939

- > Drei voneinander unabhängige Verstellmöglichkeiten, die von der Front erreichbar sind.
- > Eine extra flache Abdeckkappe, die in verschiedenen Farben erhältlich ist, verdeckt den Schrankaufhänger.
- > Lieferbar für Dübel- oder Schraubmontage.
- > Aus Stahl gefertigt und somit recyclefähig.

1	SCARPI-4		216
	■ SCARPI-4 Schrankaufhänger		216
	■ Zubehör		217
2	SCARPI-4 mit Aushängesicherung		219
	■ SCARPI-4 Schrankaufhänger mit Aushängesicherung		219
	■ Zubehör für Aushängesicherung		220

1 SCARPI-4

■ SCARPI-4 Schrankaufhänger

Schrankaufhänger, Montage mit Euroschraube.

	Links	Rechts	
Verzinkt	625.000.036	625.100.033	200

Lieferung erfolgt mit Euroschrauben.

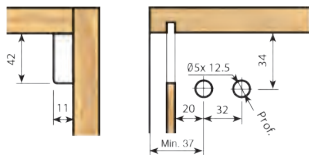

Schrankaufhänger mit Dübeln.

	Links	Rechts	
Verzinkt	625.200.030	625.300.034	200

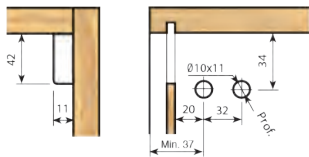

Schrankaufhänger, Schraubmontage.

	Links	Rechts	
Verzinkt	625.400.031	625.500.035	200

Lieferung erfolgt mit Schrauben Ø5x16.

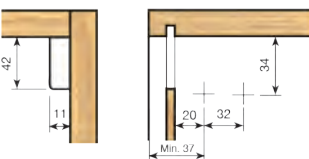

Abdeckkappe.

		Links	Rechts	
Weiß	RAL 9001	639.600.006	639.700.003	400
Weiß	RAL 9003	639.600.135	639.700.132	
Grau		639.600.146	639.700.143	
Anthrazit	RAL 7043	639.600.312	639.700.316	
Vernickelt*		639.200.063	639.300.060	

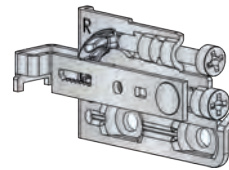

3 Verstellungen	
Höhe	13mm.
Tiefe	17mm.
Seite	8mm.

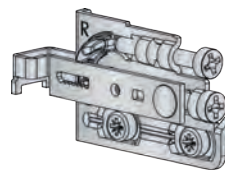
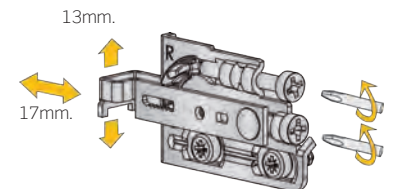

3 Verstellungen	
Höhe	13mm.
Tiefe	17mm.
Seite	8mm.

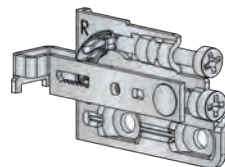

3 Verstellungen	
Höhe	13mm.
Tiefe	17mm.
Seite	8mm.

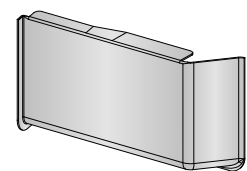
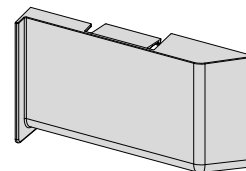

* Vernickelt

Zubehör

Zubehörbeutel.

		
Verzinkt	620.400.105	200

200 Beutel je Verpackungseinheit, jeder Beutel enthält 1 Aufhängeschiene (b), 4 Plastikdübel Ø8x40 (D) und 4 Holzschrauben Ø4,5x45.

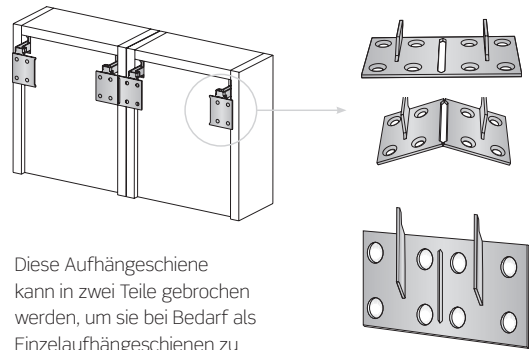

Diese Aufhängeschiene kann in zwei Teile gebrochen werden, um sie bei Bedarf als Einzelaufhängeschienen zu benutzen.

Doppelaufhängeschiene.

		
Verzinkt	623.000.033	200

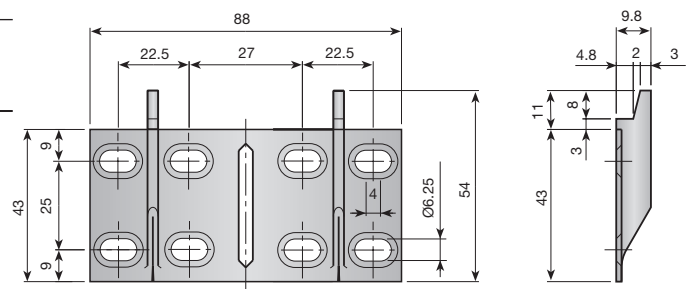

Trägerplatte.

Korpusbreite	L	Verzinkt	
200	158	623.315.033	150
250	208	623.320.036	150
300	258	623.325.032	150
350	308	623.330.035	100
400	358	623.335.031	100
450	408	623.340.034	100
500	458	623.345.030	52
550	508	623.350.033	52
600	558	623.355.036	52
650	608	623.360.032	52
700	658	623.365.035	52
750	708	623.370.031	52
800	758	623.375.034	52
900	858	623.385.033	40
1000	958	623.395.032	40
1200	1158	623.415.030	32
1350	1308	623.430.032	32

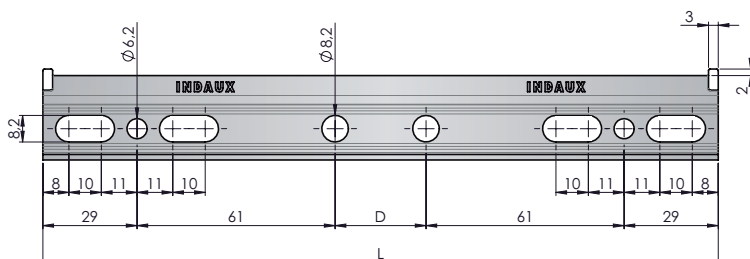
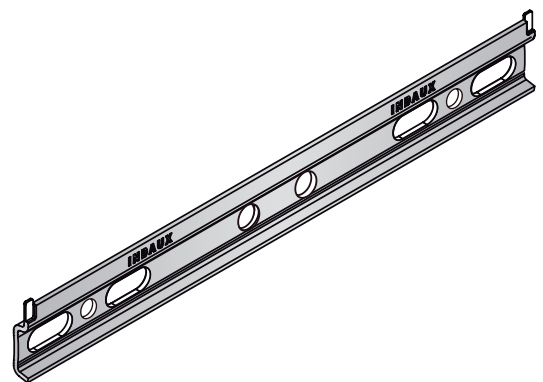

Zubehör

Doppelaufhängeschiene.

Länge (mm.)		
130	621.900.031	200

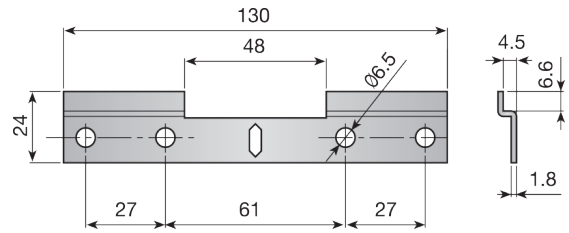

Ovalen Schraublöcher Doppelaufhängeschiene

Länge (mm.)	Verzinkt	
130	621.950.033	15

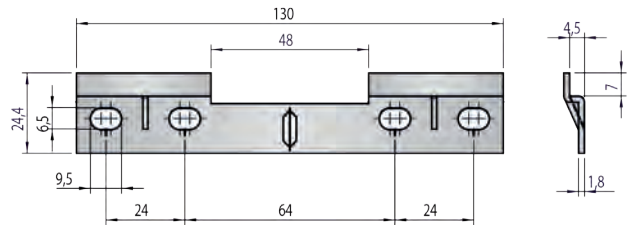

Schrauben Ø4,5 x 35.

Verzinkt		
982.435.031	5.000	



Dübel Ø6 x 30 Plastik.

Naturbelassen		
662.130.302	1.000 oder 10.000	

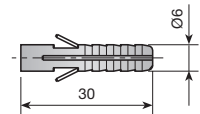

Dübel Ø8 x 40 Plastik.

Naturbelassen		
662.240.106	1.000 oder 10.000	

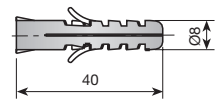

Aufhängehaken.

Verzinkt		
661.200.035	1.000	

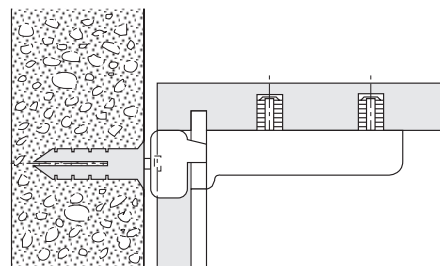
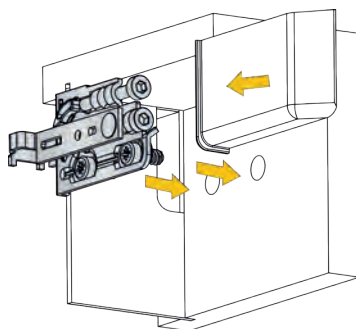
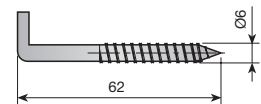

2 SCARPI-4 MIT AUSHÄNGESICHERUNG

■ SCARPI-4 Schrankaufhänger mit Aushängesicherung

Schrankaufhänger, Montage mit Euroschraube mit Aushängesicherung für Aufhängeschiene

	Links	Rechts	
Verzinkt	629.800.032	629.900.036	200

Lieferung erfolgt mit Euroschrauben.

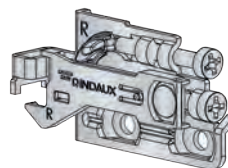
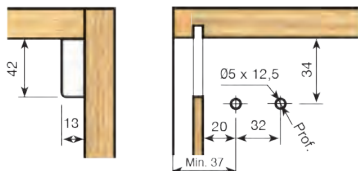

3 Verstellungen	
Höhe	13mm.
Tiefe	17mm.
Seite	6mm.

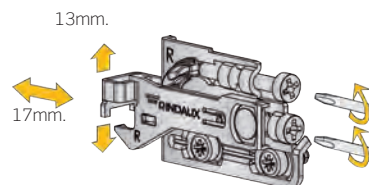

Schrankaufhänger mit Dübeln mit Aushängesicherung für Aufhängeschiene

	Links	Rechts	
Verzinkt	629.600.031	629.700.035	200

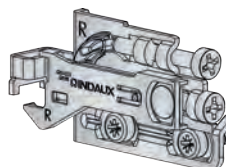
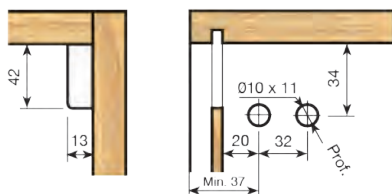

3 Verstellungen	
Höhe	13mm.
Tiefe	17mm.
Seite	6mm.

Schrankaufhänger, Schraubmontage mit Aushängesicherung für Aufhängeschiene

	Links	Rechts	
Verzinkt	629.400.030	629.500.034	200

Lieferung erfolgt mit Schrauben Ø5x16.

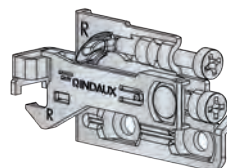
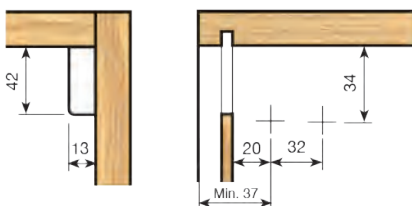

3 Verstellungen	
Höhe	13mm.
Tiefe	17mm.
Seite	6mm.

Klappe für Aushängesicherung

		Links	Rechts	
Weiß	RAL 9001	639.600.006	639.700.003	400
Weiß	RAL 9003	639.600.135	639.700.132	
Grau		639.600.146	639.700.143	
Anthrazit	RAL 7043	639.600.312	639.700.316	
Vernickelt*		639.200.063	639.300.060	

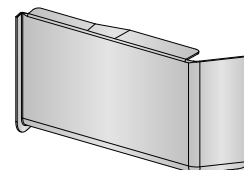
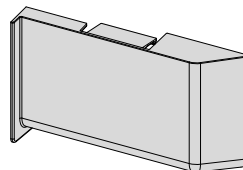

* Vernickelt

Aushängesicherung

	Links	Rechts	
Für Aufhängeschiene	629.000.492	629.100.496	200
Für Aufhängehaken	629.200.493	629.300.490	

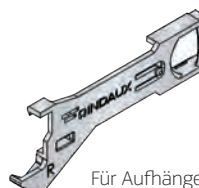

Für Aufhängeschiene

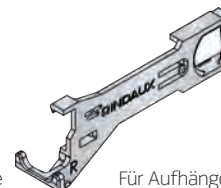

Für Aufhängehaken

Zubehör für Aushängesicherung

(Sie können auch mit dem Standardsystem verwendet werden)

Zubehörbeutel.

Verzinkt	628.950.103		200
----------	-------------	-----------------------------------------------------------------------------------	-----

200 Beutel je Verpackungseinheit, jeder Beutel enthält 2 Aufhängeschiene, 6 Plastikdübel Ø8x40 und 6 Holzschrauben Ø4,5x45.

Aufhängeschiene.

Verzinkt	628.900.031		200
----------	-------------	-----------------------------------------------------------------------------------	-----

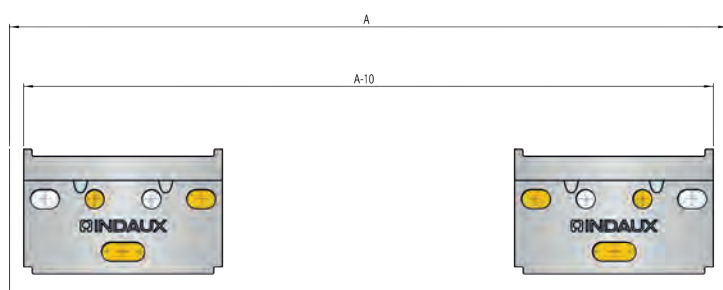
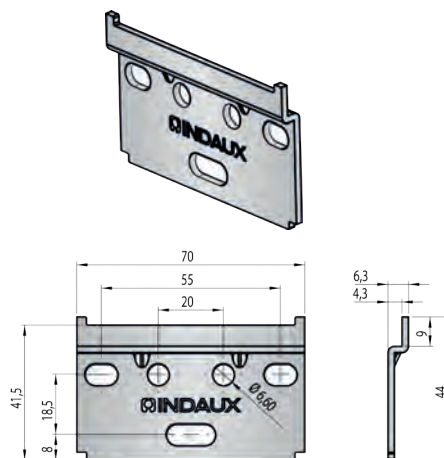

A = Lichte Breite des Möbels
* Die Schrauben sollen in den angegebenen Löcher eingesetzt werden

Trägerplatte.

Korpusbreite	L	Verzinkt	
200	158	623.315.033	150
250	208	623.320.036	150
300	258	623.325.032	150
350	308	623.330.035	100
400	358	623.335.031	100
450	408	623.340.034	100
500	458	623.345.030	52
550	508	623.350.033	52
600	558	623.355.036	52
650	608	623.360.032	52
700	658	623.365.035	52
750	708	623.370.031	52
800	758	623.375.034	52
900	858	623.385.033	40
1000	958	623.395.032	40
1200	1158	623.415.030	32
1350	1308	623.430.032	32

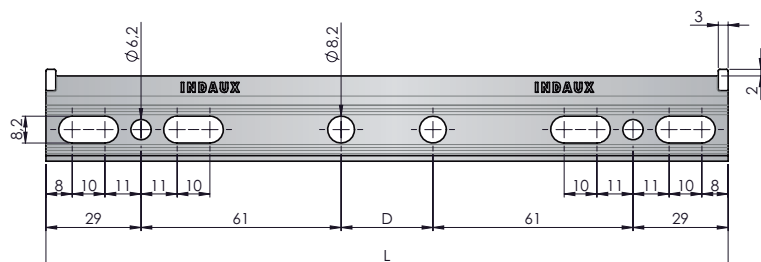

■ Zubehör

Schrauben Ø4,5 x 35.

		
Verzinkt	982.435.031	5.000



Dübel Ø6 x 30 Plastik.

		
Naturbelassen	662.130.302	1.000 oder 10.000

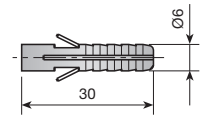

Dübel Ø8 x 40 Plastik.

		
Naturbelassen	662.240.106	1.000 oder 10.000

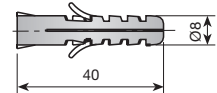

Aufhängehaken.

		
Verzinkt	661.200.035	1.000

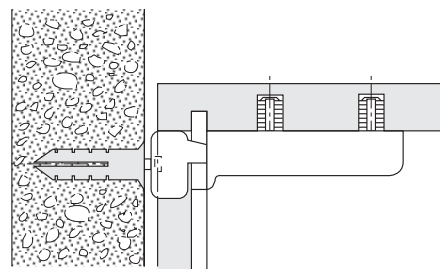
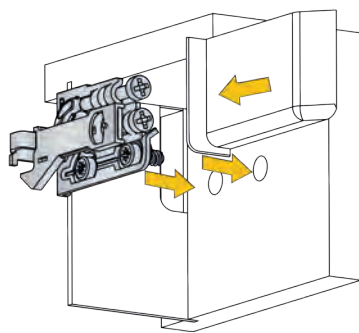
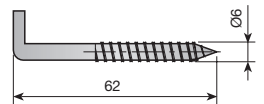

SCARPI-5

Schrankaufhänger

Hochleistungsschrankaufhänger: 35 kg/Stück im Prüfgestell A nach EN 15939.
Lieferbar für Dübel- oder Schraubmontage.

1	SCARPI-5	222
	■ SCARPI-5 Schrankaufhänger	223
	■ Zubehör	224

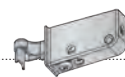

1 SCARPI-5

■ SCARPI-5 Schrankaufhänger

Hochleistungsschrankaufhänger: 35 kg/Stück im Prüfgerüst A nach EN 15939. Eine Abdeckklappe, die in verschiedenen Farben erhältlich ist, verdeckt den Schrankaufhänger.

Abdeckklappe für Schrankaufhänger Schraubmontage

		Links	Rechts	
Weiß	RAL 9001	626.250.004	626.350.001	250
Weiß	RAL 9003	626.250.133	626.350.130	

Befestigung der Aufhängung mit 2 Befestigungsschrauben Ø3,5 x 16.

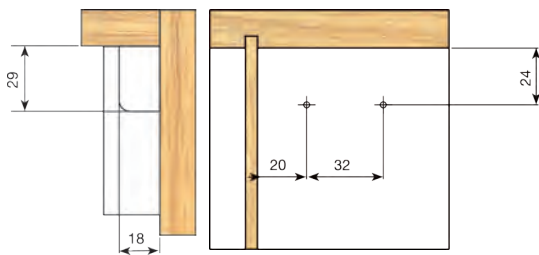
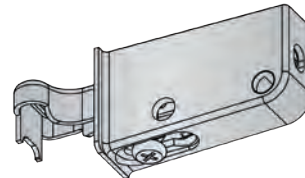

3 Verstellungen	
Höhe	14mm.
Tiefe	15mm.
Seite	6mm.

Abdeckklappe

		Links	Rechts	
Weiß	RAL9001	638.800.002	638.900.006	500
Weiß	RAL9003	638.800.131	638.900.135	

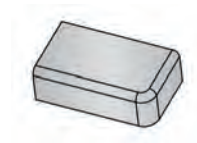

Abdeckklappe für Schrankaufhänger Dübelmontage

		Links	Rechts	
Weiß	RAL 9001	626.400.003	626.500.000	250
Weiß	RAL 9003	626.400.132	626.500.136	

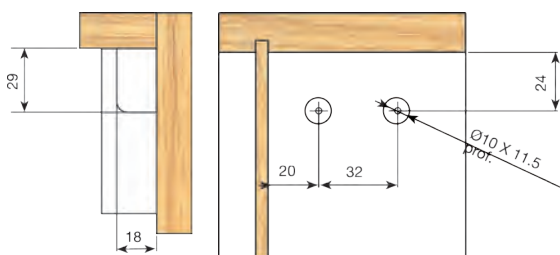
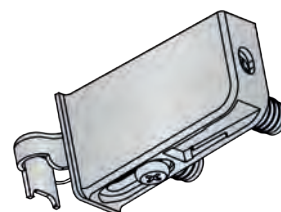

3 Verstellungen	
Höhe	14mm.
Tiefe	15mm.
Seite	6mm.

Abdeckklappe

		Links	Rechts	
Weiß	RAL 9001	639.400.005	639.500.002	500
Grau		639.400.145	639.500.142	

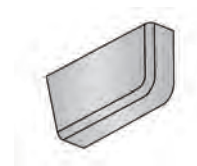

Zubehör

Zubehörbeutel Doppelaufhängeschiene.

	
620.400.105	200

200 Beuteln je Verpackungseinheit. Jeder Beutel enthält 1 Aufhängeschiene (B), 4 Plastikdübel Ø8x40 (D) und 4 Schrauben Ø4,5x45 (C).

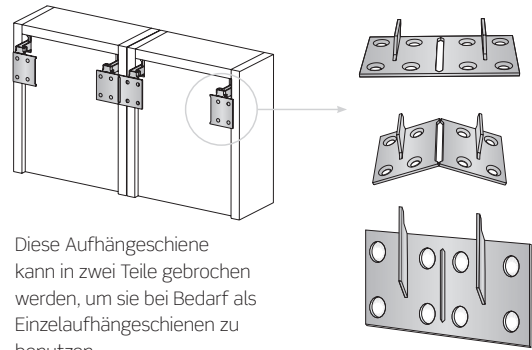

Diese Aufhängeschiene kann in zwei Teile gebrochen werden, um sie bei Bedarf als Einzelaufhängeschiene zu benutzen.

Doppelaufhängeschiene.

	
Verzinkt 623.000.033	200

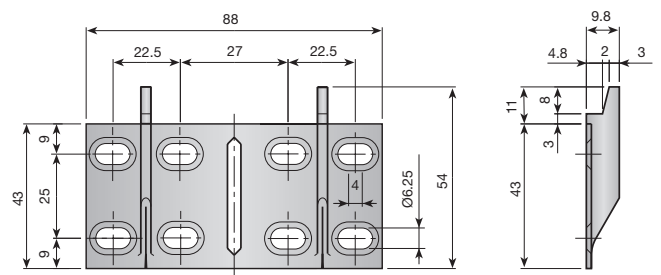

Aufhängeschiene

	
Verzinkt 626.700.034	200

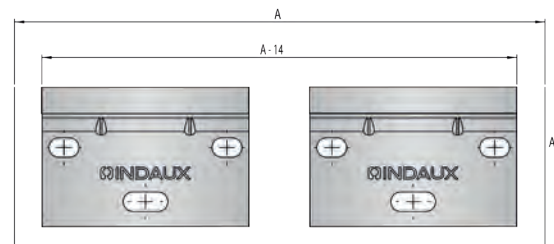
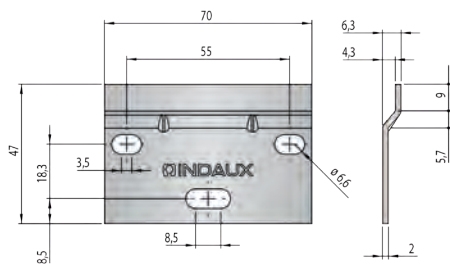

A: Lichte Breite des Möbels.

Doppelaufhängeschiene

Länge (mm)	Verzinkt	
110	626.850.033	200

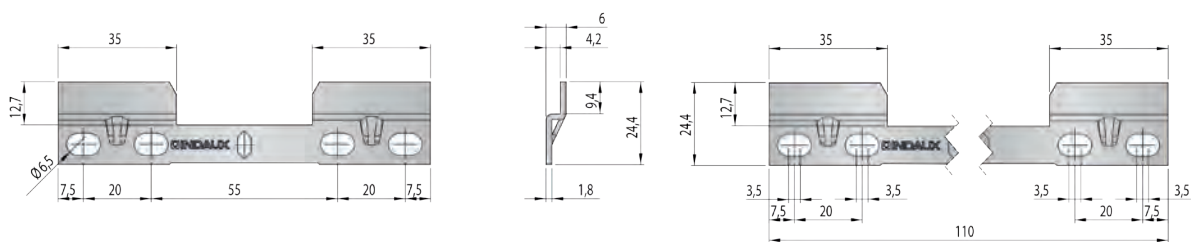
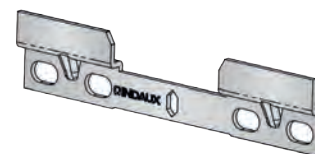

Schrauben $\varnothing 4,5 \times 35$.

		
Verzinkt	982.435.031	5.000



Dübel $\varnothing 6 \times 30$ Plastik.

		
Naturbelassen	662.130.302	1.000 oder 10.000

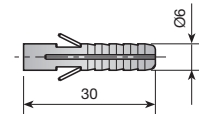

Dübel $\varnothing 8 \times 40$ Plastik.

		
Naturbelassen	662.240.106	1.000 oder 10.000

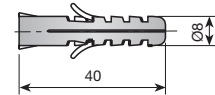

Aufhängehaken.

		
Verzinkt	661.200.035	1.000

