

EUROPA

Schubkasten Kompakt

Module zwischen 300 und 900mm. 4 zur Auswahl stehende verdeckte Führungen. Gedämpfter INDAmatic-Einzug.



INDAmatic

1 KOMPONENTEN

■ **Edelstahlschubkasten**

Edelstahlschubkasten.

Korpusbreite	Edelstahlschubkasten	
300	684.030.104	10
350	684.035.100	
400	684.040.103	
450	684.045.106	
500	684.050.102	



■ **Folienbeschichteter Stahlschubkasten**

Folienbeschichteter Stahlschubkasten.

Korpusbreite	Weiß RAL 9001	Grau	Ahorn-Honig	
300	684.130.005	684.130.311	684.130.904	10
350	684.135.001	684.135.314	684.135.900	
400	684.140.004	684.140.310	684.140.903	
450	684.145.000	684.145.313	684.145.906	
500	684.150.003	684.150.316	684.150.902	
600	684.160.002	684.160.315	684.160.901	



Folienbeschichteter Stahlschubkasten.

Korpusbreite	Grau / INDAmatic	Grau	
300	686.230.311	684.430.316	1
350	686.235.314	684.435.312	
400	686.240.310	684.440.315	
450	686.245.313	684.445.311	
500	686.250.316	684.450.314	
600	686.260.315	684.460.313	

INDAmatic

Artikelnummer enthält 5 Schubkästen mit den entsprechenden Führungen **MARC** (Teilzugzug mit Selbsteinzug), Frontadaptern und Schrauben.

■ **Plastikschubkasten gespritzt**

Plastikschubkasten gespritzt.

Korpusbreite	Weiß RAL 9001	Grau RAL 7040	
300	684.530.000	684.530.313	
350	684.535.003	684.535.316	
400	684.540.006	684.540.312	
450	684.545.002	684.545.315	
500	684.550.005	684.550.311	
600	684.560.004	684.560.310	20
900	684.590.001	684.590.314	10



INDA-matic

Plastikschubkasten gespritzt, Kit weiß RAL 9001.

	KIT 4	KIT 5*	
	INDAmatic**	INDAmatic**	
300	686.530.003	686.830.001	1
350	686.535.006	686.835.004	
400	686.540.002	686.840.000	
450	686.545.005	686.845.003	
500	686.550.001	686.850.006	
600	686.560.000	686.860.005	
900	686.590.004	686.890.002	

(*) Jedes KIT besteht aus 5 Schubkästen mit den entsprechenden **MARC**-Führungen (480mm Länge) mit Selbsteinzug, Frontadaptern und Schrauben.

(**) Mit dem Selbsteinzugs- und Dämpfungssystem **INDAmatic**.

Besteckschubkasten.

Korpusbreite	Weiß RAL 9001	Grau RAL 7040	
300	684.630.004	684.630.310	20
350	684.635.000	684.635.313	
400	684.640.003	684.640.316	
450	684.645.006	684.645.312	
500	684.650.002	684.650.315	
600	684.660.001	684.660.314	



Besteckschubkasten mit verschiebbarem Aufsatz.

Korpusbreite	Weiß RAL 9001	Grau RAL 7040	
300	684.730.001	684.730.314	5
350	684.735.004	684.735.310	
400	684.740.000	684.740.313	
450	684.745.003	684.745.316	
500	684.750.006	684.750.312	
600	684.760.005	684.760.311	



■ Schubkasten Spezialkorpusbreiten

Gespritzte Schubkastenseite.

Schubkastenlänge	Weiß RAL 9001	Grau RAL 7040	
270	683.327.002	683.327.315	
400	683.340.000	683.340.313	20
480	683.348.002	683.348.315	



Bodenberechnung

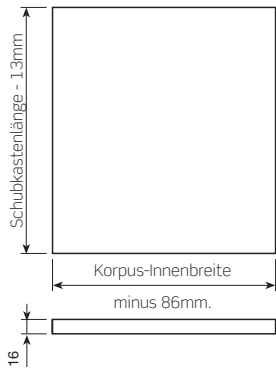

Rückwandberechnung

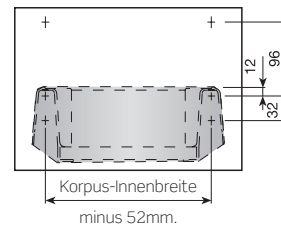
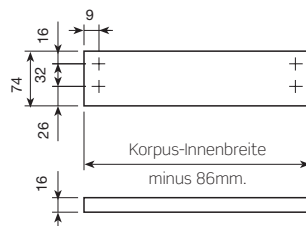

Aluminium Schubkastenseiten.

Schubkastentiefe	Silber eloxiert	
270	683.427.511	
400	683.440.516	20
480	683.448.511	



Bodenberechnung

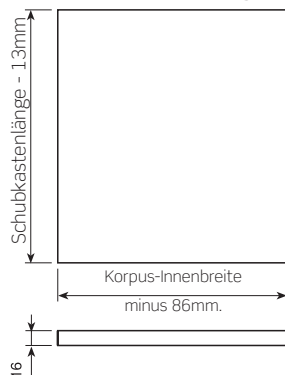

Rückwandberechnung

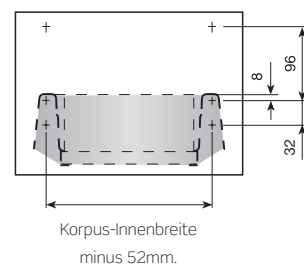
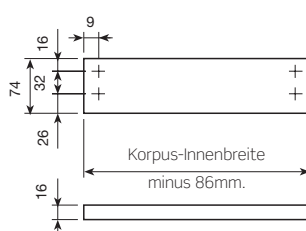

■ Führungen mit Teilauszug

MARC Unterbodenführung mit Dämpfung und vormontiertem Selbsteinzug.

Länge	Auszugsverlust	Artikelnr. Seitenteil	
	PS	16mm.	
270	50	768.827.032	
400	70	768.840.030	20
480	92	768.848.032	
520	60	768.852.033	

INDA-matic



(*)= Tatsächliche Länge= Nominallänge + 5mm, außer in der 520mm-Ausführung, bei der die tatsächliche Länge= Nominallänge ist.

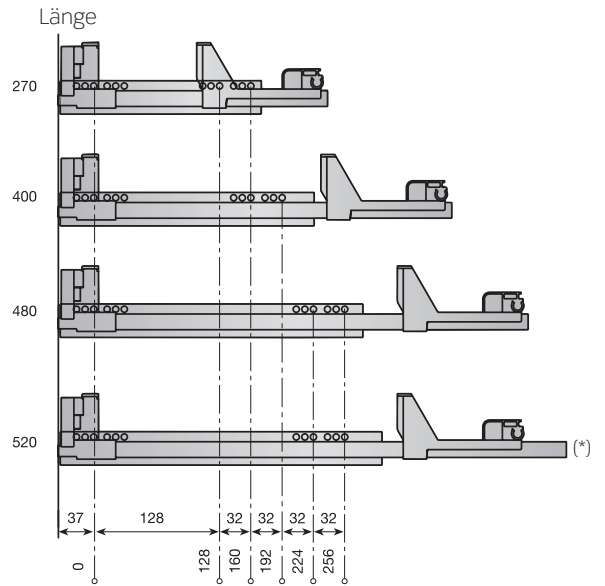
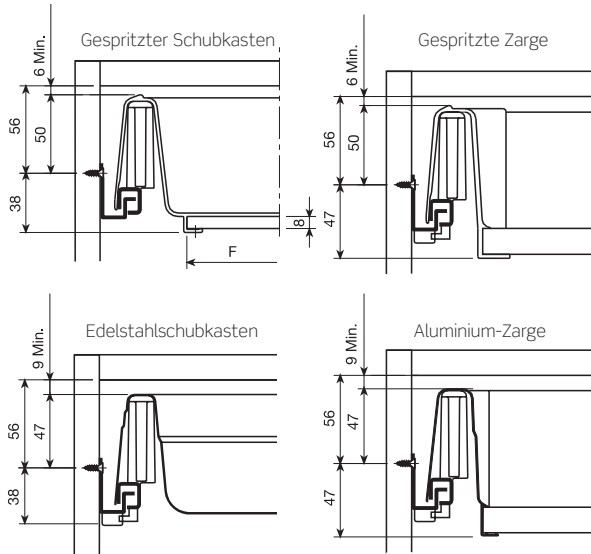

■ Frontadapter für Schubkastenführung

Frontadapter für Schubkastenführung.

Oberfläche	685.900.106	100
------------	-------------	-----

Frontbefestigung für gespritzten Schubkasten.

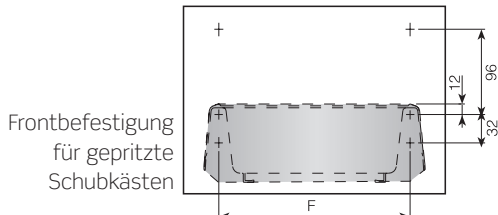

Frontbefestigung für gespritzte Schubkästen

Frontbefestigung für folienbeschichtete Stahlschubkästen und Edelstahlschubkästen.



Korpusbreite	F
300	216
350	266
400	316
450	366
500	416
600	516
700	616
800	716
900	816

2 ZUBEHÖR

■ Zubehör für Topfschubkasten

Relingsystem - verchromt.

Korpusbreite	Artikelnummer	
300	743.330.125	
350	743.335.121	
400	743.340.124	
450	743.345.120	20
500	743.350.123	
600	743.360.122	
700	743.370.121	
800	743.380.120	
900	743.390.126	

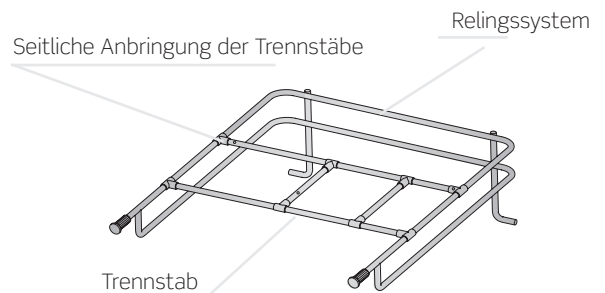

Querreling - verchromt.

Korpusbreite	Artikelnummer	
300	745.830.120	
350	745.835.123	
400	745.840.126	
450	745.845.122	50
500	745.850.125	
600	745.860.124	
700	745.870.123	
800	745.880.122	
900	745.890.121	



Relingverbinder.

Glanzoxiiert	Artikelnummer	
Grau RAL 7037	732.401.305	100

Frontbefestigung für Relingsystem.

Glanzoxiiert	Artikelnummer	
Grau RAL 7037	730.600.301	100

Artikelnummer enthält einen kompletten Satz.

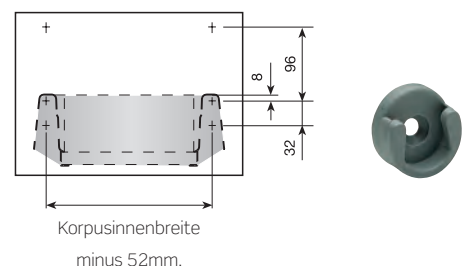

Zubehör für hohe Schubkästen mit Reling

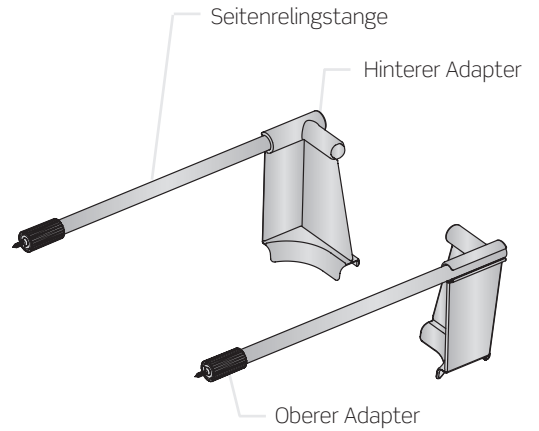
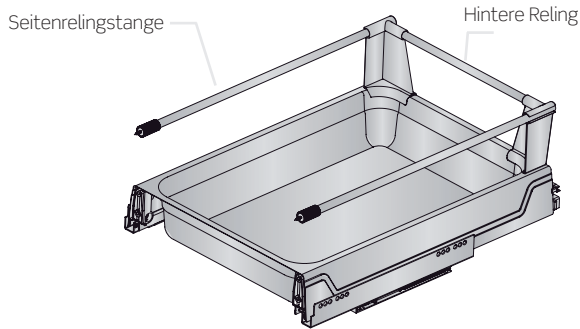

Seitenrelingstange.

Tiefe	Grau RAL 7040	
480	734.148.310	10

Jede Artikelnummer beinhaltet 1 Satz seitlicher Stäbe, 1 Satz hinterer Adapter, 1 Satz oberer Adapter. Alles nicht montiert.

Hintere Reling.

Korpusbreite	L	Grau RAL7040	
300	191	747.130.311	10
350	241	747.135.314	
400	291	747.140.310	
450	341	747.145.313	
500	391	747.150.316	
600	491	747.160.315	
700	591	747.170.314	
800	691	747.180.313	
900	791	747.190.312	
1000	891	747.191.314	
1200	1091	747.199.316	

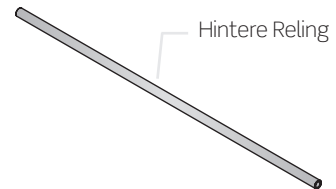

Montage und Einstellung

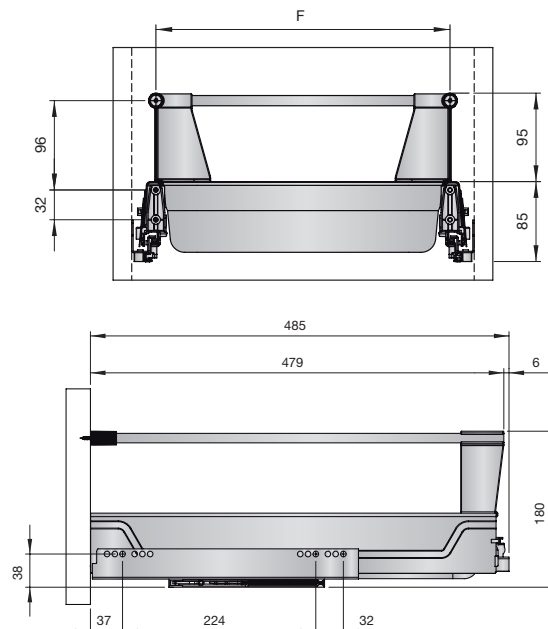

Korpusbreite	F
300	216
350	266
400	316
450	366
500	416
600	516
700	616
800	716
900	816

■ **Besteckeinsätze**

Besteckeinsatz für Stahlschubkästen.

Korpusbreite	Weiß RAL 9001	Grau RAL 7037	Ahorn-Honig	
300	687.530.001	687.530.303	687.530.911	20
350	687.535.004	687.535.306	687.535.914	
400	687.540.000	687.540.302	687.540.910	
450	687.545.003	687.545.305	687.545.913	
500	687.550.006	687.550.301	687.550.916	
600	687.560.005	687.560.300	687.560.915	



Besteckeinsatz für gespritzte Schubkästen.

Korpusbreite	Weiß	Metallic-Grau	
900	687.590.002	687.590.142	10



■ **Zierleiste für Plastischubkästenseiten**

Zierleiste für Plastischubkästenseiten.

Oberfläche	Artikelnummer	
Glanzeloxiert	664.548.500	100

Artikelnummer enthält ein kompletten Decorsatz.



■ **Dämpfungsmatte**

Dämpfungsmatte für Stahlschubkästen.

Korpusbreite	Grau RAL 7037	
300	443.130.306	20
350	443.135.302	
400	443.140.305	
450	443.145.301	
500	443.150.304	
600	443.160.303	
900	443.190.300	

