

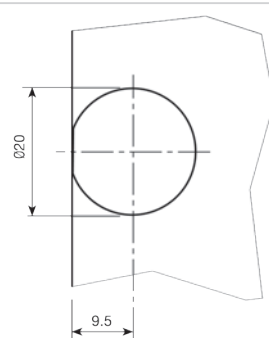

1 ASSEMBLEURS CLOCK

■ Assembleurs CLOCK Ø20

- CLOCK-1: Système de montage et démontage facile, par simple pression.
- CLOCK-2: La rotation du crochet bloque la vis, fixant l'étagère au côté.
- CLOCK-3: En tournant la vis, le boîtier serre le goujon et vient bloquer la tablette.
- CLOCK-5: Agit par pression et est doté d'un cache métallique.
- CLOCK-6: En tournant la vis, le téton se dilate et attire le panneau.



Douille de fixation Ø20mm. CLOCK-1.

C (mm.)	A(mm.)	Blanc RAL9003	Marron RAL8016	Noir RAL9005	Chêne RAL1002	
2	7	913.002.005	913.002.016	913.002.020	913.002.193	2.000
8	13	913.008.003	913.008.014	913.008.025	913.008.191	
9	14	913.009.005	913.009.016	913.009.020	913.009.193	
10	15	913.010.000	913.010.011	913.010.022	913.010.195	
12.5	17.5	913.012.004	913.012.015	913.012.026	913.012.192	
15.5	20,5	913.015.003	913.015.014	913.015.025	913.015.191	

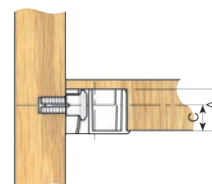

Douille de fixation Ø20mm. CLOCK-2.

C (mm.)	A(mm.)	Blanc RAL9003	Marrón RAL 8016	Noir RAL9005	Chêne RAL1002	
8	13	913.108.000	913.108.011	913.108.022	913.108.195	2.000
9	14	913.109.002	913.109.013	913.109.024	913.109.190	
10	15	913.110.004	913.110.015	913.110.026	913.110.192	

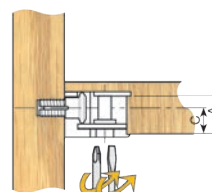

Pozidriv PZ-3
Plat 6.5 X 1.2

Douille de fixation Ø20mm. CLOCK-3.

C (mm.)	A (mm.)	Noir Zingué	Nickelé	
8	13	913.208.041	913.208.063	500
9	14	913.209.043	913.209.065	
10	15	913.210.045	913.210.060	
12,5	17,5	913.212.042	913.212.064	
15,5	20,5	913.215.041	913.215.063	

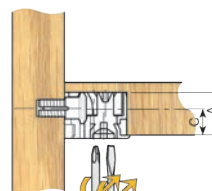

Pozidriv PZ-3
Plat 6.5 X 1.2

Douille de fixation Ø20mm. CLOCK-5.

C (mm.)	A (mm.)	Nickelé	
8	13	913.408.064	2.000
9	14	913.409.066	
10	15	913.410.061	
12,5	17,5	913.412.065	
15,5	20,5	913.415.064	

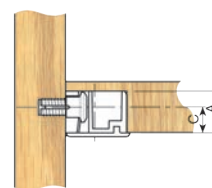

■ Vis

Goujon filet à bois pour perçage Ø3mm.

L (mm.)	Zingué	
9	923.309.030	
11	923.311.034	500 ou 5.000
14	923.314.033	

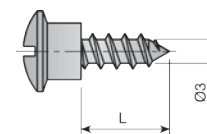

Goujon filet à bois pour perçage Ø4mm.

L (mm.)	Zingué	
9	923.409.034	
11	923.411.031	500 ou 5.000
14	923.414.030	

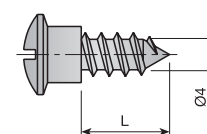

Goujon filet à bois pour perçage Ø5mm.

L (mm.)	Zingué	
7,5	923.507.034	
10	923.510.033	500 ou 5.000
13	923.513.032	

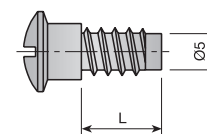

Goujon M4.

Zingué	923.708.030	
		500 ou 5.000

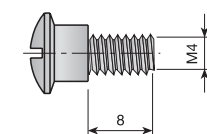

Goujon autoexpansile.

Noir	RAL 9005	922.905.023	
			500 ou 5.000

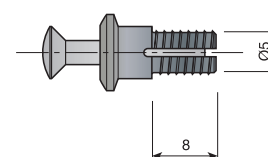

Écrou expansible en laiton M4.

Naturel	944.805.105	
		2.000 ou 10.000

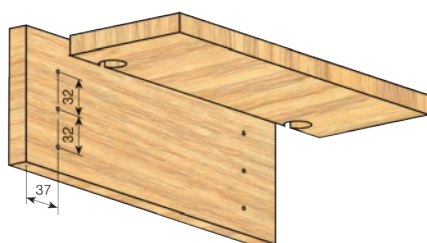
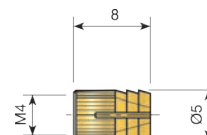

■ Assembleurs CLOCK-6 Ø20

Douille de fixation CLOCK-6, courte.

C (mm.)	A (mm.)	Nickelé	
8	13	526.108.063	
9	14	526.109.065	
10	15	526.110.060	500
12.5	17.5	526.112.064	
15.5	26.5	526.115.063	

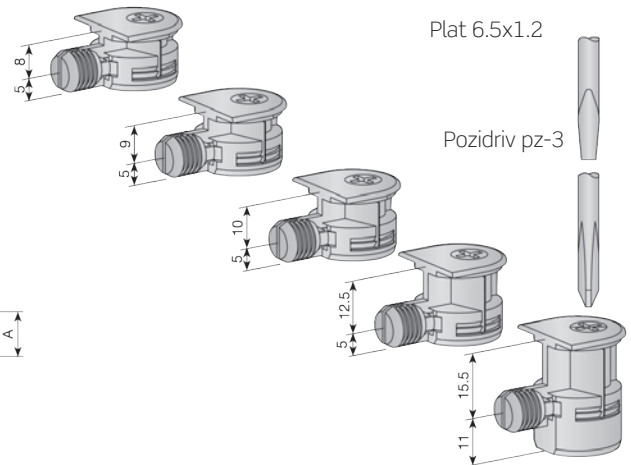
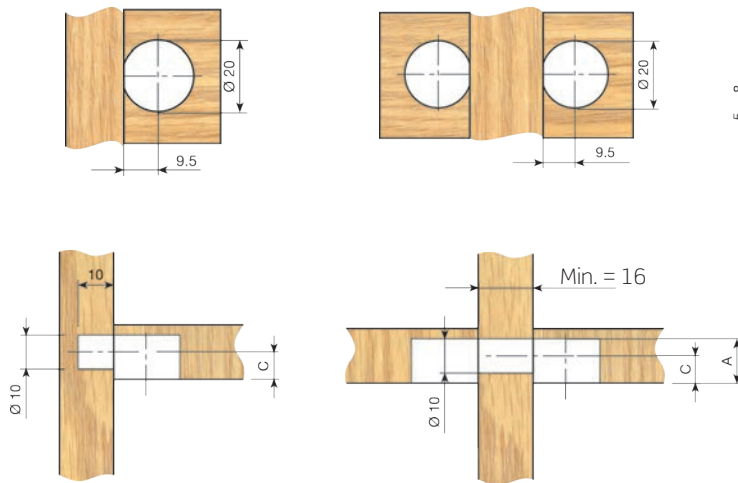

Douille de fixation CLOCK-6, longue.

C (mm.)	A (mm.)	Nickelé	
8	13	526.008.066	
9	14	526.009.061	
10	15	526.010.063	500
12.5	17.5	526.012.060	
15.5	26.5	526.015.066	

