

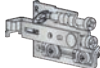

SCARPI-4

Suspension armoires

Suspension haute résistance: 45Kg/unité sur structure d'essai A et 35Kg/unité sur structure d'essai B selon EN 15939

- > Permet trois réglages indépendants, facilement accessibles depuis la façade.
- > La suspension reste dissimulée sous un cache extraplat de différentes couleurs.
- > Disponible pour montage à frapper, avec vis, euro vis.
- > Fabrication en acier facilitant le recyclage postérieur.

1	SCARPI-4		216
	■ Suspension SCARPI-4		216
	■ Accessoires		217
2	SCARPI-4 avec système de sécurité		219
	■ Suspension SCARPI-4 avec système de sécurité		219
	■ Accessoires pour système de sécurité		220

1 SCARPI-4

■ Suspension SCARPI-4

Montage à visser euro vis.

	Gauche	Droite	
Zingué	625.000.036	625.100.033	200

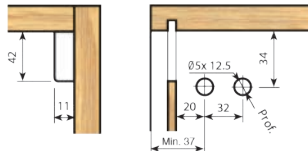

Montage à frapper.

	Gauche	Droite	
Zingué	625.200.030	625.300.034	200

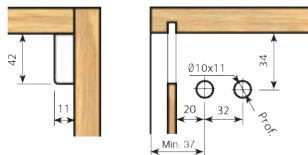

Montage avec vis.

	Gauche	Droite	
Zingué	625.400.031	625.500.035	200

Livré avec vis de Ø5 x 16.

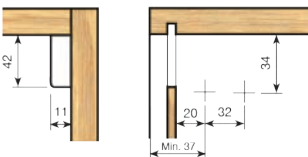

Caches.

		Gauche	Droite	
Blanc	RAL 9001	639.600.006	639.700.003	400
Blanc	RAL 9003	639.600.135	639.700.132	
Gris		639.600.146	639.700.143	
Anthracite	RAL 7043	639.600.312	639.700.316	
Nickelé*		639.200.063	639.300.060	

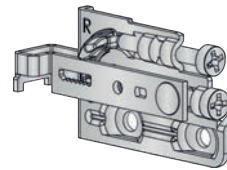

3 Réglages	
Hauteur	13mm.
Frontal	17mm.
latéral	8mm.

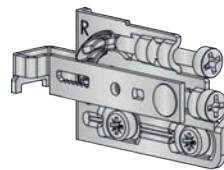
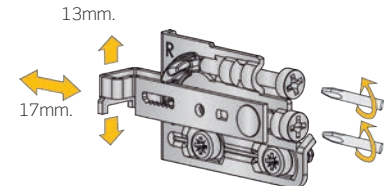

3 Réglages	
Hauteur	13mm.
Frontal	17mm.
latéral	8mm.

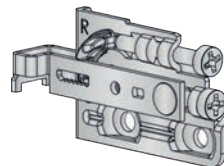

3 Réglages	
Hauteur	13mm.
Frontal	17mm.
latéral	8mm.

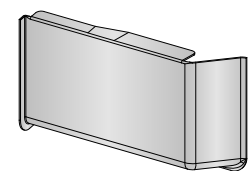
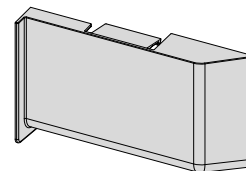

* Nickelé

■ Accessoires

Sachet d'accessoires.

Zingué	620.400.105		200
--------	-------------	---	-----

En boîte de 200 sachets. Chaque sachet contient:
1 plaque (b), 4 vis Ø4,5 x 45 (c), 4 chevilles en plastique Ø8 x 40 (d).

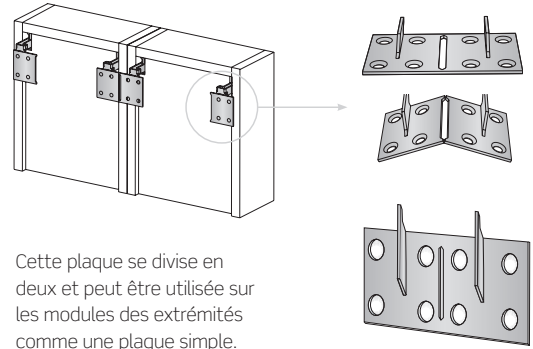

Cette plaque se divise en deux et peut être utilisée sur les modules des extrémités comme une plaque simple.

Plaque murale double.

Zingué	623.000.033		200
--------	-------------	---	-----

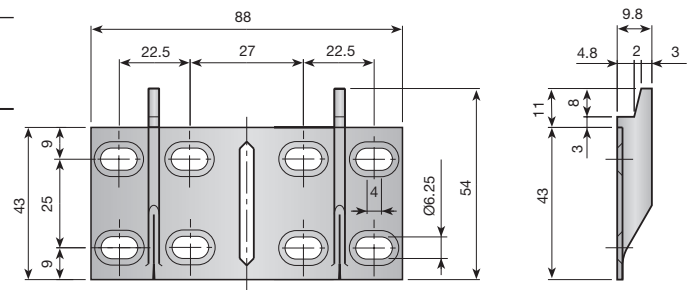

Plaque double.

Longueur (mm)	L	Zingué	
200	158	623.315.033	150
250	208	623.320.036	150
300	258	623.325.032	150
350	308	623.330.035	100
400	358	623.335.031	100
450	408	623.340.034	100
500	458	623.345.030	52
550	508	623.350.033	52
600	558	623.355.036	52
650	608	623.360.032	52
700	658	623.365.035	52
750	708	623.370.031	52
800	758	623.375.034	52
900	858	623.385.033	40
1000	958	623.395.032	40
1200	1158	623.415.030	32
1350	1308	623.430.032	32

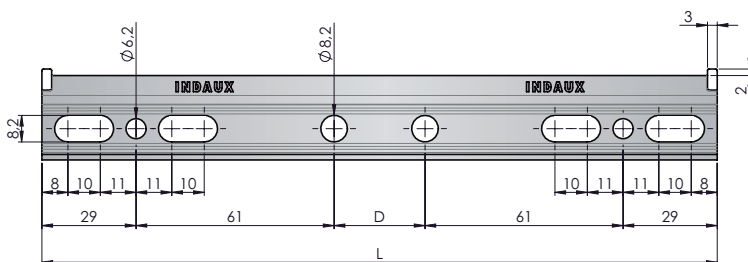

■ Accessoires

Plaque double.

Longueur (mm)		
130	621.900.031	200

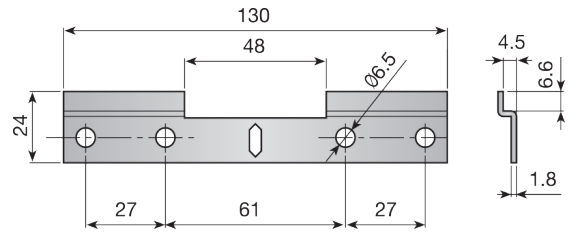

Plaque doublé avec trous ovales

Longueur (mm)	Zingué	
130	621.950.033	15

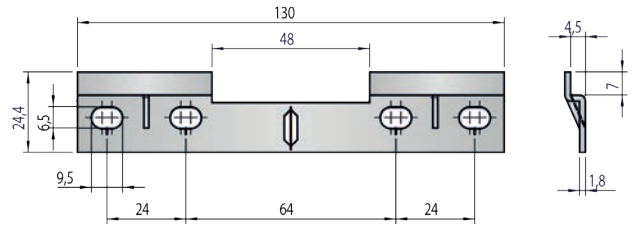

Vis Ø4,5 x 35.

Zingué		
982.435.031	5.000	



Chevilles en plastique Ø6 x 30.

Naturel		
662.130.302	1.000 ou 10.000	

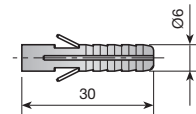

Chevilles en plastique Ø8 x 40.

Naturel		
662.240.106	1.000 ou 10.000	

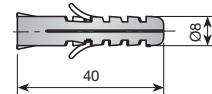

Crochet fileté.

Zingué		
661.200.035	1.000	

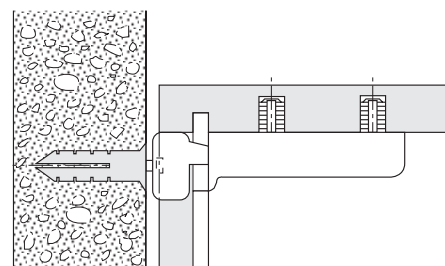
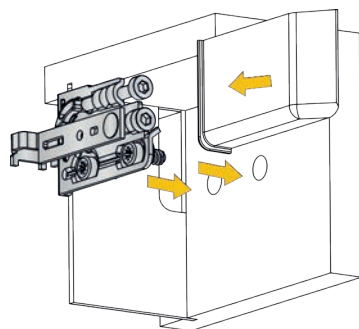
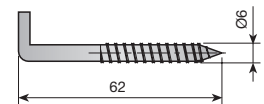

2 SCARPI-4 AVEC SYSTÈME DE SÉCURITÉ

■ Suspension SCARPI-4 avec système de sécurité

Montage à visser euro vis avec système de sécurité pour plaque

	Gauche	Droite	
Zingué	629.800.032	629.900.036	200

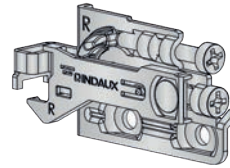
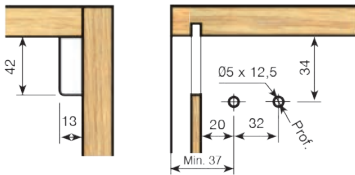

3 Réglages	
Hauteur	13mm.
Frontal	17mm.
latéral	6mm.

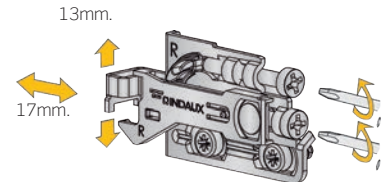

Montage à frapper avec système de sécurité pour plaque

	Gauche	Droite	
Zingué	629.600.031	629.700.035	200

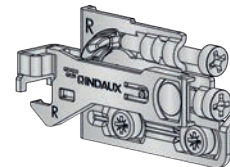
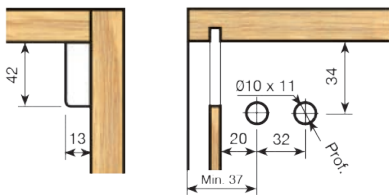

3 Réglages	
Hauteur	13mm.
Frontal	17mm.
latéral	6mm.

Montage avec vis avec système de sécurité pour plaque

	Gauche	Droite	
Zingué	629.400.030	629.500.034	200

Livré avec vis de Ø5 x 16.

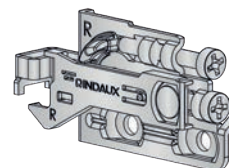
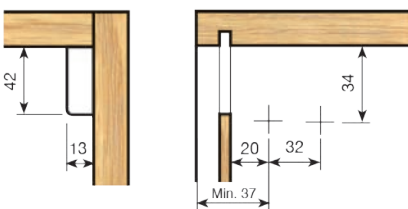

3 Réglages	
Hauteur	13mm.
Frontal	17mm.
latéral	6mm.

Caches pour système de sécurité

		Gauche	Droite	
Blanc	RAL 9001	639.600.006	639.700.003	400
Blanc	RAL 9003	639.600.135	639.700.132	
Gris		639.600.146	639.700.143	
Anthracite	RAL 7043	639.600.312	639.700.316	
Nickelé*		639.200.063	639.300.060	

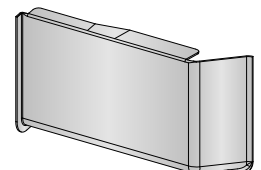
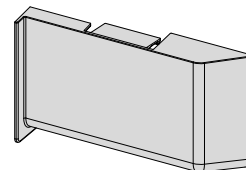

* Nickelé

Clip anti décrochement

	Gauche	Droite	
Pour plaque	629.000.492	629.100.496	200
Pour crochet fileté	629.200.493	629.300.490	



Pour plaque

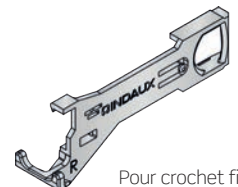

Pour crochet fileté

■ Accessoires pour système de sécurité
(peuvent également être utilisés avec le système standard)

Sachet d'accessoires.

Zingué	628.950.103		200
--------	-------------	---	-----

En boîte de 200 sachets. Chaque sachet contient:
2 plaques, 6 vis Ø4,5 x 45, 6 chevilles en plastique Ø8 x 40.

Plaque mural.

Zingué	628.900.031		200
--------	-------------	---	-----

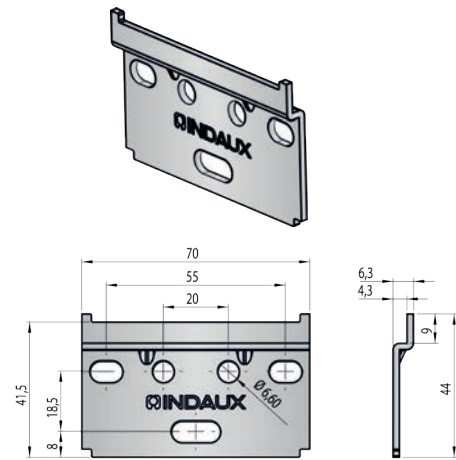
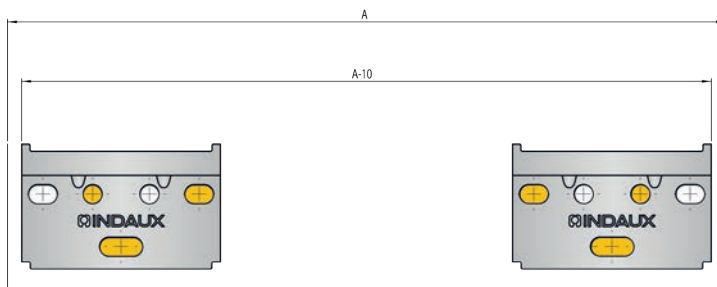

A: Largeur intérieure du caisson
* Les vis doivent être fixées dans les trous indiqués

Plaque double.

Longueur (mm)	L	Zingué	
200	158	623.315.033	150
250	208	623.320.036	150
300	258	623.325.032	150
350	308	623.330.035	100
400	358	623.335.031	100
450	408	623.340.034	100
500	458	623.345.030	52
550	508	623.350.033	52
600	558	623.355.036	52
650	608	623.360.032	52
700	658	623.365.035	52
750	708	623.370.031	52
800	758	623.375.034	52
900	858	623.385.033	40
1000	958	623.395.032	40
1200	1158	623.415.030	32
1350	1308	623.430.032	32

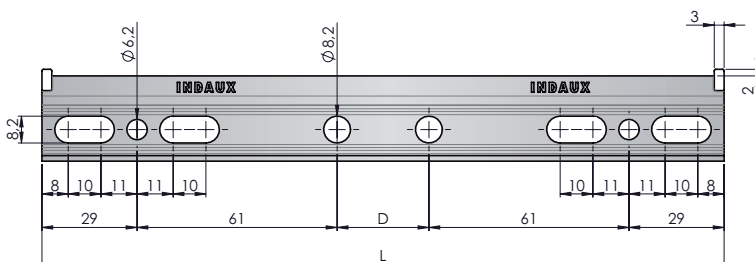
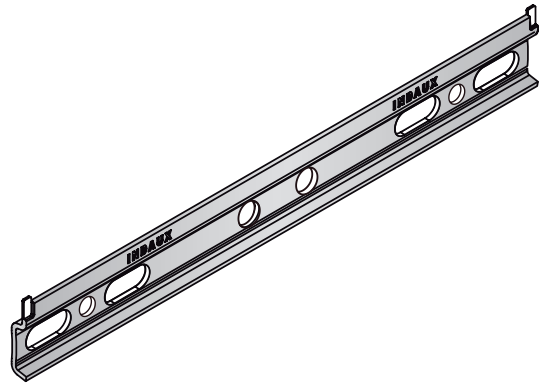

■ Accessoires

Vis Ø4,5 x 35.

		
Zingué	982.435.031	5.000



Chevilles en plastique Ø6 x 30.

		
Naturel	662.130.302	1.000 ou 10.000

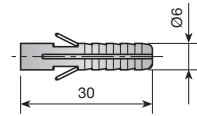

Chevilles en plastique Ø8 x 40.

		
Naturel	662.240.106	1.000 ou 10.000

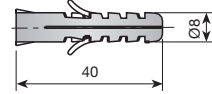

Crochet fileté.

		
Zingué	661.200.035	1.000

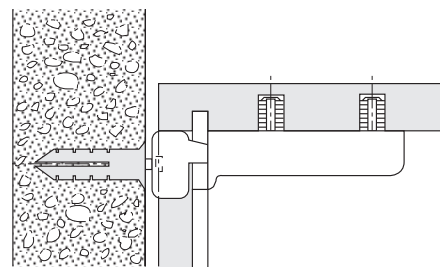
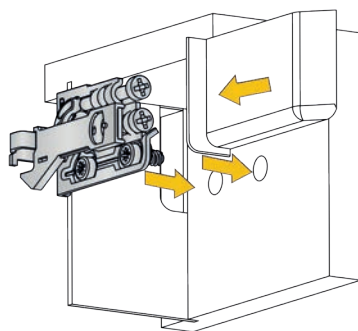
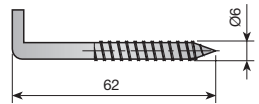

SCARPI-5

Suspension armoires

Suspension haute résistance: 35Kg/unité sur structure d'essai A selon EN 15939.
Disponible pour montage à frapper ou à visser.

1	SCARPI-5		222
	■ Suspension SCARPI-5		223
	■ Accessoires		224

1 SCARPI-5

■ Suspension SCARPI-5

Suspension haute résistance: 35Kg/unité sur structure d'essai A selon EN 15939. La suspension reste dissimulée sous un cache de différentes couleurs.

Caches pour suspension armoires- montage à visser

		Gauche	Droite	
Blanc	RAL 9001	626.250.004	626.350.001	250
Blanc	RAL 9003	626.250.133	626.350.130	

Fixation de la suspension avec 2 vis Ø3,5 x 16.

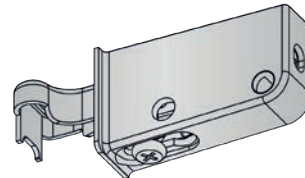
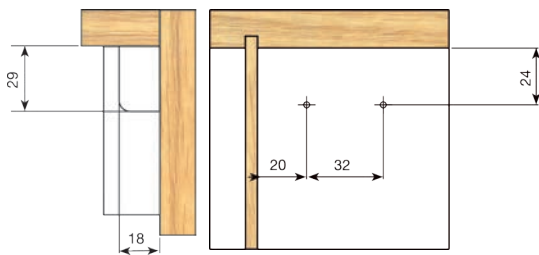

3 Réglages	
Hauteur	14mm.
Frontal	15mm.
Latéral	6mm.

Caches

		Gauche	Droite	
Blanc	RAL9001	638.800.002	638.900.006	500
Blanc	RAL9003	638.800.131	638.900.135	



Caches pour suspension armoires- montage à frapper

		Gauche	Droite	
Blanc	RAL 9001	626.400.003	626.500.000	250
Blanc	RAL 9003	626.400.132	626.500.136	

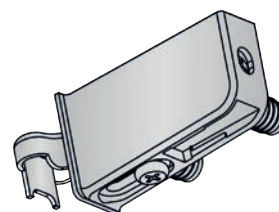
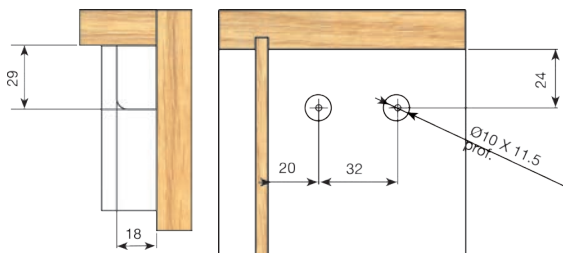

3 Réglages	
Hauteur	14mm.
Frontal	15mm.
Latéral	6mm.

Caches

		Gauche	Droite	
Blanc	RAL 9001	639.400.005	639.500.002	500
Gris		639.400.145	639.500.142	

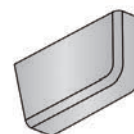

■ Accessoires

Sachet d'accessoires.

Zingué	620.400.105		200
--------	-------------	---	-----

En boîte de 200 sachets. Chaque sachet contient:
1 plaque (b), 4 vis Ø4,5 x 45 (c), 4 chevilles en plastique Ø8 x 40 (d).

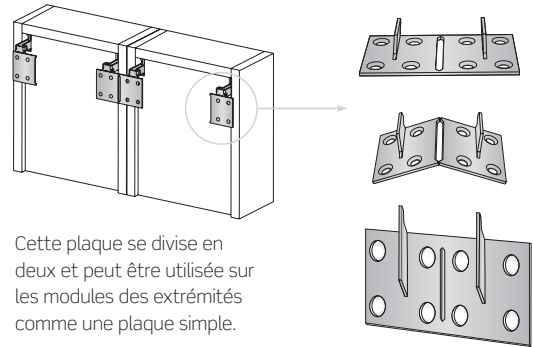

Cette plaque se divise en deux et peut être utilisée sur les modules des extrémités comme une plaque simple.

Plaque murale double.

Zingué	623.000.033		200
--------	-------------	---	-----

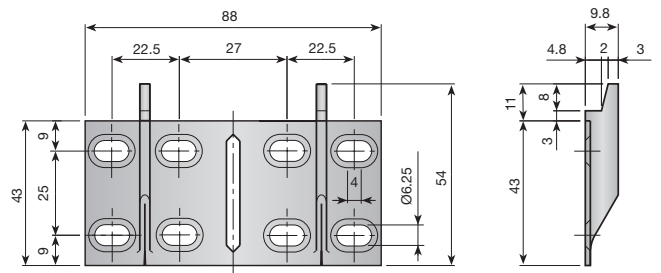

Plaque mural

Zingué	626.700.034		200
--------	-------------	---	-----

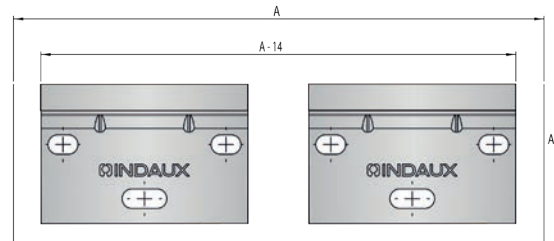
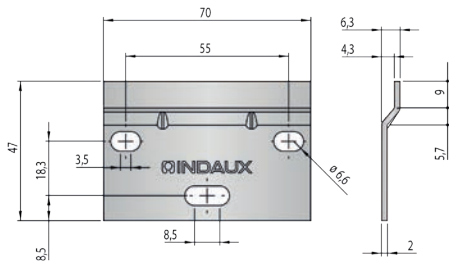

A: Largeur intérieure du caisson.

Plaque double

Longueur (mm)	Zingué		200
110	626.850.033		

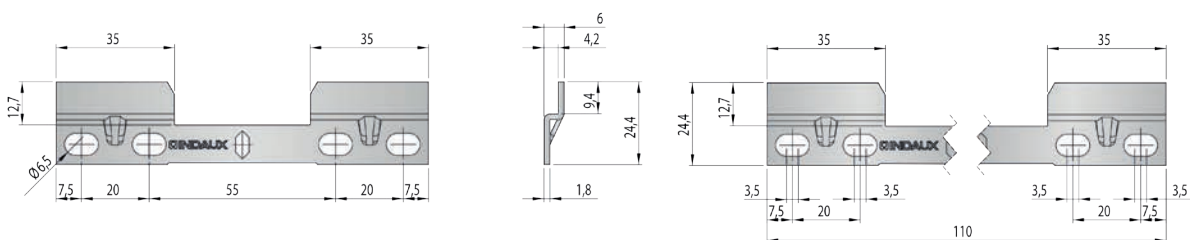
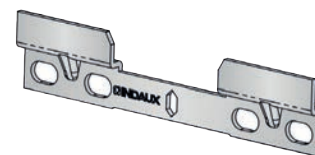

Vis Ø4,5 x 35.

		
Zingué	982.435.031	5.000



Chevilles en plastique Ø6 x 30.

		
Naturel	662.130.302	1.000 ou 10.000

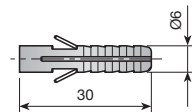

Chevilles en plastique Ø8 x 40.

		
Naturel	662.240.106	1.000 ou 10.000

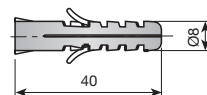

Crochet fileté.

		
Zingué	661.200.035	1.000

