



1 SCREEN CLICK

Pour tableau en bois jusqu'à 12mm.

Profil supérieur/inférieur.

	Barres de 3m.	
Anodisé satiné	718.130.501	10
Anodisé noir	718.130.545	

Profil latéral.

	Barres de 3m.	
Anodisé satiné	718.030.504	10
Anodisé noir	718.030.541	

Profil traverse centrale.

	Barres de 3m.	
Anodisé satiné	718.230.505	10
Anodisé noir	718.230.542	

Adaptateur clip pour verre.

	Barres de 3m.	
Anodisé satiné	718.330.502	10
Anodisé noir	718.330.546	

Cache latéral.

	Barres de 3m.	
Anodisé satiné	718.430.506	10
Anodisé noir	718.430.543	

Cache latéral pour butée.

	Barres de 3m.	
Anodisé satiné	718.530.503	10
Anodisé noir	718.530.540	

Butée.

	Barres de 3m.	
Noir	753.430.020	10

Joint plastique pour verre.

Épaisseur du verre	Barres de 3m.	
4mm.	753.734.026	25
5mm.	753.735.021	

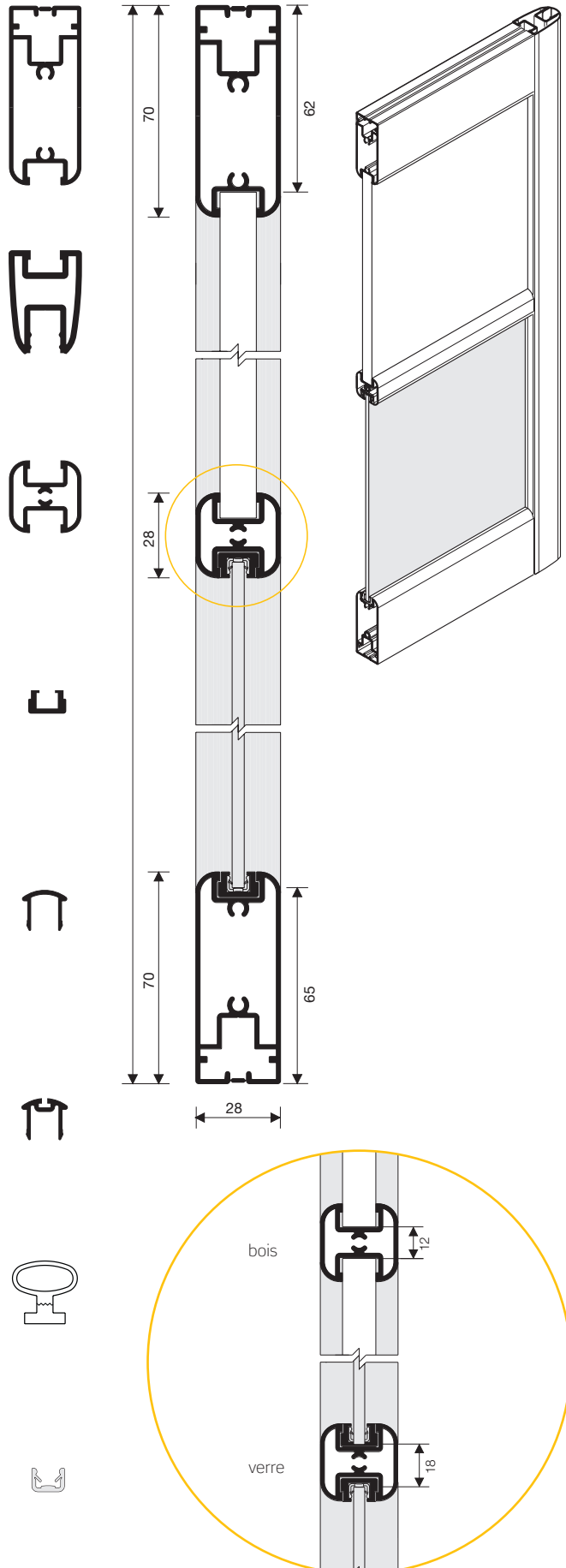

Vis din 7981 Ø4,2x32 montage joints.

		
Zingué	986.132.033	200

Vis din 965m 4x15 montage porte.

		
Zingué	726.015.032	500

Vis

		
Ø5 x 19mm	986.019.031	500

■ Spécifications techniques

Assemblage

